



Professional manufacturer of dimmable LED driver in China

100-277VAC

for 120V&277V dimmer
or intelligent illumination control system

Dimmable LED Driver

C.V. & C.C. 10W-384W



- Triac/ Phase-cut
- Triac & 0/1-10V 5 in 1
- 0/1-10V
- DALI & Push-Dim 2 in 1
- Non - Dimmable driver

Linear Version
30W-100W (Triac, 0/1-10V, DALI&Push)



CERULEAN LIMITED

Address: No.9, Est YuanMei Rd, NanCheng District, DongGuan,
GuangDong, China - 523073
Office Tel: 0086 769 8907 7505
24H Hotline: 0086 150 1314 5991
Website: www.cerulean-power.com
Email: sales@cerulean-power.com



CERULEAN LIMITED

Professional manufacturer of dimmable LED driver in China

About CERULEAN POWER -

Founded in 2009, Cerulean Power specializes in R&D and manufacturing dimmable LED driver, non-dimmable LED driver and LED controller based on science and technology in its early days. After years' of striving, Cerulean has formed competitive strength in the field of dimmable LED driver and become leader in China by offering LED driver with the widest range of wattage & full-lined series, the most models, and the most authoritative certifications in this aspect of mainstream dimmable LED driver, which includes 0/1-10V dimming, TRIAC/Phase-cut dimming, DALI dimming, Push dimming, ZigBee wireless dimming, etc.

Cerulean's dimmable and non-dimmable LED drivers have been recognized by the market of mainland China. Moreover, quite a few major government and business projects, have adopted our LED driver as reliable products, such as Beijing YanQi Lake APEC/G20 Villa, Shanghai International Convention Center (the banquet of CICA Summit), Shanghai Sheraton Hotel, Changsha Wanda Plaza and Shunde Marriott Hotel, etc ..

With its stable quality, smooth linear dimming, high compatibility and other advantages, Cerulean's dimmable drivers have been well received by customers in all over the world. Nowadays, with UL, cUL, ETL, cETL, FCC, TUV-CE, CB, SAA, BIS, RoHS and other certificates, Cerulean's products have been exported to numerous oversea markets such as North America, Europe, Australia, Southeast Asia, and so on ...

Advanced manufacturing equipments, including JUKI-Hi-speed mountings and Suneast wave solderings and others, promise the high capacity up to 200,000 pieces product per month.

We sincerely look forward to cooperating with friends from all over the world and achieve a win-win situation!



2009	0/1-10V C.C. 20W-60W
2010	0/1-10V C.V. & C.C. 100W-200W
2011	0/1-10V C.V. & C.C. 20W-80W
2012	Triac/Phase-cut C.V. & C.C. 20W-200W
2013	DALI C.V. & C.C. 20W-200W
2014	Triac/Phase-cut C.V. 100W-200W
	ZigBee wireless C.V. & C.C. 20W-45W

2015	DALI& Push Dim 2 in1 C.V. & C.C. 25W-200W	2016	Triac/Phase-cut PWM output C.V. 8W-200W	2017	Triac/Phase-cut High PF KVF series C.V. 30W-360W	2018	Triac/Phase-cut High PF KVF series C.V. 384W Din Rail 60W-100W
	0/1-10V C.V. 300W-360W		Triac& 0/1-10V 5 in 1 High PF KVG series C.V. 384W Din Rail 60W-100W		Triac LED controller 0-10V LED controller DALI LED controller		Triac& 0/1-10V 5 in 1 High PF KVG series C.V. 384W Din Rail 60W-100W
	DALI&Push-Dim C.V. 300W-360W		0/1-10V 4 in 1 High PF KVD series C.V. 30W-384W Din Rail 60W-100W				

Development history of Cerulean Power's dimmable products

Factory Pictures



Certificates



UL Listed



ETL Listed



FCC



RoHS

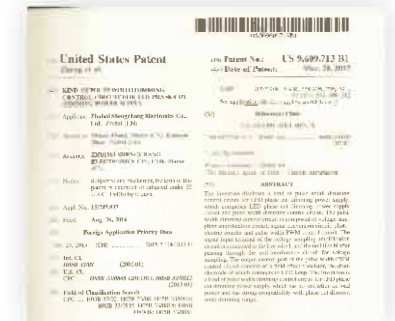

United States Patent

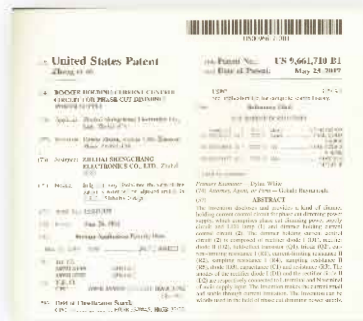

United States Patent

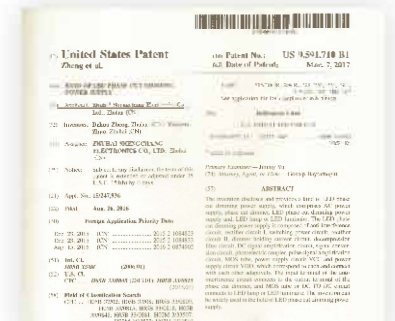

United States Patent

Some projects with Cerulean dimmable LED drivers

Shanghai W Hotel



Shunde Marriott Hotel



Shanghai International Convention Center
(Banquet Hall of CICA Summit)



Some projects with Cerulean dimmable LED drivers

Beijing Yanqi Lake APEC / G20 Villa



Shanghai Jiading Sheraton Hotel



Changsha Wanda Plaza



Some projects with Cerulean dimmable LED drivers

Crowne Plaza Sanya Haitang Bay Resort



Sanya Beauty Crown



Shanghai Sincere Centre



Some projects with Cerulean dimmable LED drivers

THE ICON - Shenzhen



Funlu Shanju Spring Resort Hotel



Argylehotels (Nanping)



Contents

Part 1

Triac/ Phase-cut dimmable LED driver series

- P3 Junction Box/ Enclosure
- P4-P12 Constant voltage driver — KVF series — **High power factor, PWM output** (P4-P8) **NEW**
 - Din rail driver (P9) **NEW**
 - KVP series — **PWM output** (P10-P11)
 - KV series (P12)
- P13-P15 Constant current driver — KI series (P13-P14)
 - KIP series — **DIP adjustment** (P15)

Part 2

Triac/ 0-10V/1-10V/10V PWM/Potentiometer(5 in 1) dimmable LED driver series **NEW**

- P18-P23 Constant voltage driver — KVG series — **High power factor, PWM output** (P18-P22)
 - **Class 2 Multiple Output** (P21-P22)
 - **Din rail driver** (P23)

Part 3

0-10V/ 1-10V/potentiometer/ 10V PWM (4 in 1) dimmable LED driver series

- P21-P22 Constant voltage driver— KVD series — **High power factor** (P27-P30) **NEW**
 - **Din rail driver** (P31) **NEW**
- P32-P33 Constant voltage driver— KV-DIM series
- P34-P35 Constant current driver
- P36 Constant current driver — **DIP adjustment**

Part 4

DALI dimmable LED driver series

- P40-P41 Constant voltage driver
- P42-P43 Constant current driver
- P44 Constant current driver — **DIP adjustment**

Part 5

Non-dimmable series-PFC EMC high power factor

- P47-P51 PFC EMC high power factor driver (UL listed constant voltage driver - High PF)

Triac/ Phase cut dimmable LED driver

Differences Between KVG, KVF, KVP & KV Series For Americas' market

	KVG series	KVF series	KVP series	KV series
Input Voltage(AC)	100-277V	100-277V (30W-120W) 110-277V (150W-300W)	100-130V	100-130V
Output Voltage(DC)	12V/24V	12V/24V	12V/24V	12V/24V/36V/48V
Wattage Range	30W-384W	30W-384W	25W-200W	10W-80W
Compatibility	Triac/ Forward and Reverse phase (leading and trailing edge)/ MLV/ ELV dimmer +0/1-10V Dimming	Triac/ Forward and Reverse phase (leading and trailing edge)/ MLV/ ELV dimmer	Triac/ Forward phase (leading edge)/ MLV/ ELV dimmer	Triac/ Forward and Reverse phase (leading and trailing edge)/ MLV/ ELV dimmer
Power Factor	>0.95	>0.95	>0.65	>0.95
Mini.Load	10%	10%	5%	60%
Warranty	5 years	5 years	3 years	3 years
Class 2	30W-96W & MULTI 2×96W/ 3×60W/ 3×96W/ 5×60W	30W-96W & MULTI 2×96W/ 3×60W/ 3×96W/ 5×60W	25W-96W	10W-80W
Certificate	UL/cUL listed pending, FCC pending, RoHS	UL/cUL listed, FCC, RoHS	ETL/cETL listed, FCC, RoHS	ETL/cETL listed, FCC, RoHS

PART 1

Triac/ Phase-Cut Dimmable LED Driver Series

(Forward and reverse phase dimming / Leading edge & Trailing edge dimming)
 (For LED strip, light bar, LED module, panel, down light and other LED light)



30W-100W



30W-100W



10W-20W



25W-60W



30W-60W



60W-384W



30W-384W

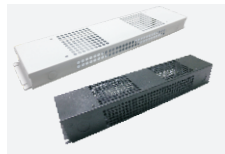

Driver with Junction Box



Wiring diagram

Diagram 1

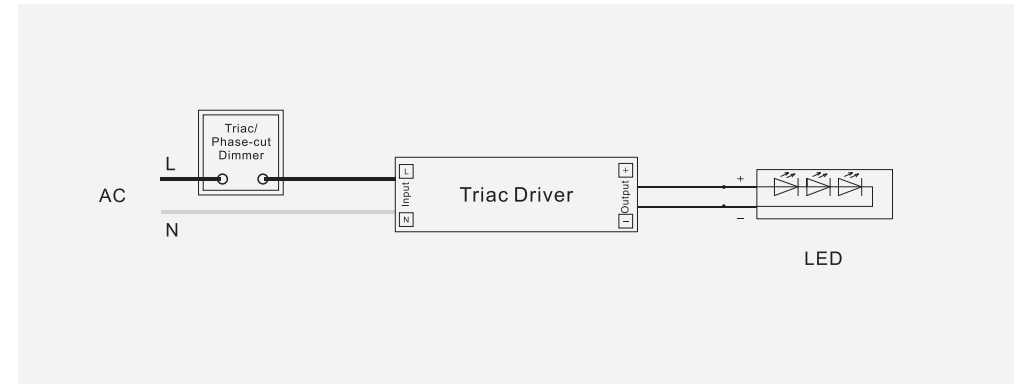
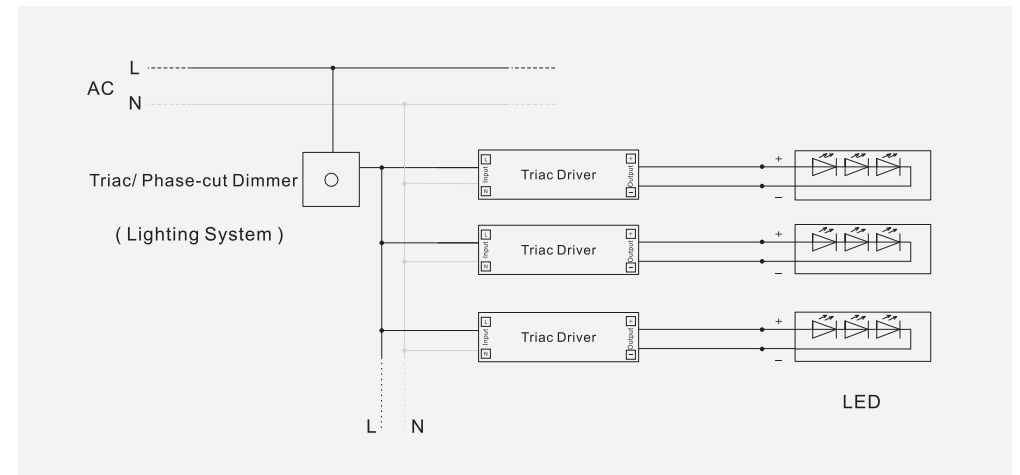



Diagram 2



Junction Box / Enclosure

Junction box/ Enclosure for 25W-200W

	Model	Size	N.W.	for Dimmable driver
	J10	350*77*26mm	470g	For UL/ETL listed LED driver 25W-60W
	J12-1	350*77*37mm	520g	60W KVP-XXX-TDL model
	J12-5	350*77*37mm	520g	For UL/ETL listed LED driver 25W-60W
	J2	350*77*57mm	600g	60W-80W KV/KI-XXX-TDL model
	J5	380*77*57mm	640g	For UL/ETL listed LED driver 80W-120W
	J8	406*87*60mm	730g	For UL/ETL listed LED driver 150W-200W
	J30	455*87*60mm	820g	For UL/ETL listed LED driver 180W-300W
	J42-1	249*98*38mm	510g	60W KVP-XXX-TDL model
	J42-2	249*98*38mm	500g	60W KVP-XXX-TDL model
	J35-1	280*112*57mm	730g	80W-120W KVP-XXX-TDL model
	J38-1	309*116*57mm	810g	150W-200W KVP-XXX-TDL model
	J35-2	280*112*57mm	720g	80W-120W KVP-XXX-TDL model
	J38-2	309*116*57mm	800g	150W-200W KVP-XXX-TDL model

KVF Series

Triac/ Phase-cut Dimming - Constant Voltage

PF > 0.95 Loading: 10-100% Dimming: 0-100% 5 years warranty

 Class 2 Class P TYPE HL RoHS

for 120V&277V dimmer
or intelligent illumination control system

Overview

CERULEAN'S PWM 100-277VAC universal KVF of Constant Voltage UL and cUL Listed AC phase-cut /triac dimming LED driver, designed to work with Forward & Reverse phase (Leading & trailing edge) dimmer, MLV, ELV and other TRIAC dimmers such as Lutron, Leviton , Crestron etc ..

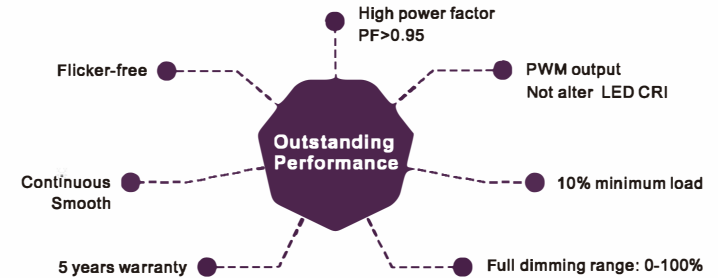

Different versions

KVF-xxxxx-TDW



30W-60W items:
Low-profile plastic enclosure for dry and damp location
80W-300W Items:
Compact aluminum enclosure for wet, dry, damp location

KVF-xxxxx-TDWS



30W-100W items:
Linear plastic shell for dry and damp location

KVF-xxxxx-TDWL



30W-100W items:
Linear aluminum shell for wet, dry, damp location

KVF-xxxxx-TDWJ



30W-300W items:
Dimmable LED Driver built-in Junction box

KVF-xxxxx-TDWJV2



30W-300W items:
Dimmable LED Driver with Junction box

KVF-Cxxxxx-TDW&TDWJ



180W-384W items:
Multiple independent outputs groups. High power driver but still Class 2 unit

KVF-xxxxx-TDWR



60W-100W items:
Dimmable din rail driver

Perfect for LED fixtures

Perfectly fit LED tape/strip, modules, LED bar light, cabinet light, kitchen light and other LED fixtures.



KVF Series

Triac/ Phase-cut Dimming - Constant Voltage

PF > 0.95 Loading: 10-100% Dimming: 0-100% 5 years warranty



for 120V&277V dimmer
or intelligent illumination control system

Power & Picture	Model	Output	Input	Certificate	Size	N.W.	Location
30W Class 2 	KVF-12030-TDW	10-13V, 2.5A	100-277 VAC	UL, cUL, FCC, Class2, RoHS	155*54*20mm	0.21kg	Dry, Damp
	KVF-24030-TDW	21.5-25.5V, 1.25A					
	KVF-12030-TDWJ	12V, 2.5A		UL, cUL, FCC, Class2, RoHS	165*92*26mm	0.7kg	Dry, Damp
	KVF-24030-TDWJ	24V, 1.25A					
	KVF-12030-TDWJV2	10-13V, 2.5A		UL, cUL, FCC, Class2, RoHS	J10: 350*77*26mm	J10: 0.7kg	Dry, Damp
	KVF-24030-TDWJV2	21.5-25.5V, 1.25A			J12-5: 350*77*37mm	J12-5: 0.8kg	
	KVF-12030-TDWS	12V, 2.5A		UL, cUL, FCC Pending Class2, RoHS	260*30*18.5mm	0.2kg	Dry, Damp
	KVF-24030-TDWS	24V, 1.25A					
	KVF-12030-TDWL	12V, 2.5A		UL, cUL, FCC Pending Class2, RoHS	260*32*20mm	0.35kg	Wet, Dry, Damp
	KVF-24030-TDWL	24V, 1.25A					
36W Class 2 	KVF-12036-TDWS	12V, 3A	100-277 VAC	UL, cUL, FCC Pending Class2, RoHS	260*30*18.5mm	0.2Kg	Dry, Damp
	KVF-24036-TDWS	24V, 1.5A					
	KVF-12036-TDWL	12V, 3A		UL, cUL, FCC Pending Class2, RoHS	260*32*20mm	0.35Kg	Dry, Damp
	KVF-24036-TDWL	24V, 1.5A					
60W Class 2 	KVF-12060-TDW	10-13V, 5A	100-277 VAC	UL, cUL, FCC, Class2, RoHS	178*61*24mm	0.35kg	Dry, Damp
	KVF-24060-TDW	21.5-25.5V, 2.5A					
	KVF-12060-TDWJ	12V, 5A		UL, cUL, FCC, Class2, RoHS	188*92*26mm	0.81kg	Dry, Damp
	KVF-24060-TDWJ	24V, 2.5A					
	KVF-12060-TDWJV2	10-13V, 5A		UL, cUL, FCC, Class2, RoHS	J10: 350*77*28mm	J10: 0.81kg	Dry, Damp
	KVF-24060-TDWJV2	21.5-25.5V, 2.5A			J12-5: 350*77*37mm	J12-5: 0.9kg	
	KVF-12060-TDWS	12V, 5A		UL, cUL, FCC Pending Class2, RoHS	300*30*18.5mm	0.3kg	Dry, Damp
	KVF-24060-TDWS	24V, 2.5A					
	KVF-12060-TDWL	12V, 5A		UL, cUL, FCC Pending Class2, RoHS	300*32*20mm	0.45kg	Wet, Dry, Damp
	KVF-24060-TDWL	24V, 2.5A					

Note: These drivers with slightly adjustable output voltage as below:
KVF-12030-TDW KVF-12060-TDW output voltage: 10-13V
KVF-12030-TDWV2 KVF-12060-TDWV2 output voltage: 10-13V

KVF-24030-TDW KVF-24060-TDW output voltage: 21.5-25.5V
KVF-24030-TDWV2 KVF-24060-TDWV2 output voltage: 21.5-25.5V

KVF Series

Triac/ Phase-cut Dimming - Constant Voltage

PF > 0.95 Loading: 10-100% Dimming: 0-100% 5 years warranty



for 120V&277V dimmer
or intelligent illumination control system

Power & Picture	Model	Output	Input	Certificate	Size	N.W.	Location
80W Class 2 	KVF-12080-TDW	12V, 6.66A	100-277 VAC	UL, cUL, FCC, Class2, RoHS	230*70*43mm	1.05kg	Wet, Dry, Damp
	KVF-24080-TDW	24V, 3.33A					
	KVF-12080-TDWJ	12V, 6.66A		UL, cUL, FCC, Class2, RoHS	220*93*41mm	1.37kg	Dry, Damp
	KVF-24080-TDWJ	24V, 3.33A					
	KVF-12080-TDWJV2	12V, 6.66A		UL, cUL, FCC, Class2, RoHS	380*77*57mm	1.7kg	Dry, Damp
	KVF-24080-TDWJV2	24V, 3.33A					
96W Class 2 	KVF-24096-TDW	24V, 4A	100-277 VAC	UL, cUL, FCC, Class2, RoHS	230*70*43mm	1.05kg	Wet, Dry, Damp
	KVF-24096-TDWJ	24V, 4A					
	KVF-24096-TDWJV2	24V, 4A		UL, cUL, FCC, Class2, RoHS	380*77*57mm	1.7kg	Dry, Damp
	KVF-24096-TDWS	24V, 4A					
	KVF-24096-TDWS	24V, 4A		UL, cUL, FCC Pending Class2, RoHS	330*30*22mm	0.4kg	Dry, Damp
	KVF-24096-TDWL	24V, 4A					
100W 	KVF-12100-TDW	12V, 8.33A	100-277 VAC	UL, cUL, FCC, RoHS	230*70*43mm	1.05kg	Wet, Dry, Damp
	KVF-24100-TDW	24V, 4.16A					
	KVF-12100-TDWJ	12V, 8.33A		UL, cUL, FCC, RoHS	220*93*41mm	1.37kg	Dry, Damp
	KVF-24100-TDWJ	24V, 4.16A					
	KVF-12100-TDWJV2	12V, 8.33A		UL, cUL, FCC, RoHS	380*77*57mm	1.7kg	Dry, Damp
	KVF-24100-TDWJV2	24V, 4.16A					
	KVF-12100-TDWS	12V, 6.33A		UL, cUL, FCC Pending RoHS	330*30*22mm	0.4kg	Dry, Damp
	KVF-24100-TDWS	24V, 4.17A					
	KVF-12100-TDWL	12V, 8.33A		UL, cUL, FCC Pending RoHS	330*32*23mm	0.55kg	Wet, Dry, Damp
	KVF-24100-TDWL	24V, 4.17A					

KVF Series

Triac/ Phase-cut Dimming - Constant Voltage

PF > 0.95 Loading: 10-100% Dimming: 0-100% 5 years warranty



for 120V&277V dimmer
or Intelligent Illumination control system

Power & Picture	Model	Output	Input	Certificate	Size	N.W.	Location	
 With J5	KVF-12120-TDW	12V, 10A	100-277VAC	UL, cUL, FCC, RoHS	230*70*43mm	1.05kg	Wet, Dry, Damp	
	KVF-24120-TDW	24V, 5A						
		KVF-12120-TDWJ		12V, 10A	UL, cUL, FCC, RoHS	220*93*41mm	1.37kg	Dry, Damp
		KVF-24120-TDWJ		24V, 5A				
	 With J5	KVF-12120-TDWJV2		12V, 10A	UL, cUL, FCC, RoHS	380*77*57mm	1.7kg	Dry, Damp
		KVF-24120-TDWJV2		24V, 5A				
 With J8	KVF-12150-TDW	12V, 12.5A	110-277 VAC	UL, cUL, FCC, RoHS	256*78*47mm	1.5kg	Wet, Dry, Damp	
	KVF-24150-TDW	24V, 6.25A						
		KVF-12150-TDWJ		12V, 12.5A	UL, cUL, FCC, RoHS	260*103*46mm	2.0kg	Dry, Damp
		KVF-24150-TDWJ		24V, 6.25A				
	 With J8	KVF-12150-TDWJV2		12V, 12.5A	UL, cUL, FCC, RoHS	406*87*60mm	2.3kg	Dry, Damp
		KVF-24150-TDWJV2		24V, 6.25A				
 With J30	KVF-C12180-TDW (MULTI 3*80W)	12V, MULTI 3*5A	100-277 VAC	UL, cUL, FCC Pending Class2, RoHS	256*78*47mm	1.5kg	Wet, Dry, Damp	
	KVF-C12180-TDWJ (MULTI 3*60W)	12V, MULTI 3*5A		UL, cUL, FCC Pending Class2, RoHS	278*108*46mm	2.0kg	Dry, Damp	
	KVF-C12180-TDWJV2 (MULTI 3*60W)	12V, MULTI 3*5A		UL, cUL, FCC Pending Class2, RoHS	455*87*60mm	2.3kg	Dry, Damp	
 With J30	KVF-C24192-TDW (MULTI 2*96W)	24V, MULTI 2*4A	100-277 VAC	UL, cUL, FCC Pending Class2, RoHS	256*78*47mm	1.5kg	Wet, Dry, Damp	
	KVF-C24192-TDWJ (MULTI 2*96W)	24V, MULTI 2*4A		UL, cUL, FCC Pending Class2, RoHS	278*108*46mm	2.0kg	Dry, Damp	
	KVF-C24192-TDWJV2 (MULTI 2*98W)	24V, MULTI 2*4A		UL, cUL, FCC Pending Class2, RoHS	455*87*60mm	2.3kg	Dry, Damp	

KVF Series

Triac/ Phase-cut Dimming - Constant Voltage

PF > 0.95 Loading: 10-100% Dimming: 0-100% 5 years warranty



for 120V&277V dimmer
or Intelligent Illumination control system

Power & Picture	Model	Output	Input	Certificate	Size	N.W.	Location	
 With J8	KVF-12200-TDW	12V, 16.6A	110-277 VAC	UL, cUL, FCC, RoHS	258*78*47mm	1.5kg	Wet, Dry, Damp	
	KVF-24200-TDW	24V, 8.33A						
		KVF-12200-TDWJ		12V, 16.6A	UL, cUL, FCC, RoHS	280*103*46mm	2.0kg	Dry, Damp
		KVF-24200-TDWJ		24V, 8.33A				
	 With J8	KVF-12200-TDWJV2		12V, 16.6A	UL, cUL, FCC, RoHS	406*87*60mm	2.3kg	Dry, Damp
		KVF-24200-TDWJV2		24V, 8.33A				
 With J30	KVF-C24288-TDW (MULTI 3*98W)	24V, MULTI 3*4A	100-277 VAC	UL, cUL, FCC Pending Class2, RoHS	301*78*47mm	1.9kg	Wet, Dry, Damp	
	KVF-C24288-TDWJ (MULTI 3*96W)	24V, MULTI 3*4A		UL, cUL, FCC Pending Class2, RoHS	301*108*46mm	2.3kg	Dry, Damp	
	KVF-C24288-TDWJV2 (MULTI 3*96W)	24V, MULTI 3*4A		UL, cUL, FCC Pending Class2, RoHS	455*87*80mm	2.57kg	Dry, Damp	
 With J30	KVF-12300-TDW	12V, 25A	110-277 VAC	UL, cUL, FCC, RoHS	276*78*47mm	1.7kg	Wet, Dry, Damp	
	KVF-24300-TDW	24V, 12.5A						
		KVF-12300-TDWJ		12V, 25A	UL, cUL, FCC, RoHS	278*108*46mm	2.3kg	Dry, Damp
		KVF-24300-TDWJ		24V, 12.5A				
 With J30	KVF-C12300-TDW (MULTI 5*60W)	12V, MULTI 5*5A	100-277 VAC	UL, cUL, FCC Pending Class2, RoHS	301*78*47mm	1.7kg	Wet, Dry, Damp	
	KVF-C12300-TDWJ (MULTI 5*60W)	12V, MULTI 5*5A		UL, cUL, FCC Pending Class2, RoHS	301*108*46mm	2.3kg	Dry, Damp	
	KVF-C12300-TDWJV2 (MULTI 5*60W)	12V, MULTI 5*5A		UL, cUL, FCC Pending Class2, RoHS	455*87*60mm	2.5kg	Dry, Damp	
 With J30	KVF-C24384-TDW (MULTI 4*96W)	24V, MULTI 4*4A	100-277 VAC	UL, cUL, FCC Pending Class2, RoHS	322*78*47mm	2kg	Wet, Dry, Damp	
	KVF-C48384-TDW (MULTI 4*96W)	48V, MULTI 4*2A						
	KVF-C24384-TDWJ (MULTI 4*96W)	24V, MULTI 4*4A		UL, cUL, FCC Pending Class2, RoHS	327*108*46mm	2.4kg	Dry, Damp	
KVF-C48384-TDWJ (MULTI 4*96W)	48V, MULTI 4*2A							

KVF Series



- Din Rail LED Driver

UL LISTED FC Class 2 Class P TYPE HL RoHS

Triac/ Phase-cut Dimming - Constant Voltage

PF > 0.95 Loading: 10-100% Dimming: 0-100% 5 years warranty

for 120V&277V dimmer

Power & Picture	Model	Output	Input	Certificate	Size	N.W.	Location
60W 	KVF-12060-TDWR	12V, 5A	100-277VAC	UL, cUL, FCC Pending Class2, RoHS	40*90*100mm	0.3kg	Dry, Damp
	KVF-24060-TDWR	24V, 2.5A		UL, cUL, FCC Pending Class2, RoHS	40*90*100mm	0.3kg	Dry, Damp
96W 	KVF-24096-TDWR	24V, 4A	100-277VAC	UL, cUL, FCC Pending Class2, RoHS	55*90*100mm	0.4kg	Dry, Damp
100W 	KVF-12100-TDWR	12V, 8.33A	100-277VAC	UL, cUL, FCC Pending, RoHS	55*90*100mm	0.4kg	Dry, Damp
	KVF-24100-TDWR	24V, 4.17A		UL, cUL, FCC Pending, RoHS	55*90*100mm	0.4kg	Dry, Damp

KVP Series

Triac/Phase-cut Dimming - Constant Voltage

Loading: 5-100% Dimming: 0-100%

UL LISTED FC Class 2 RoHS

Overview

CERULEAN'S PWM KVP (25W-200W) series of Constant Voltage ETL/cETL Listed AC phase-cut/triac dimming LED driver provides outstanding LED dimming performance, continuous smooth full range flicker-free dimming, and was designed to work with a wide range of MLV & ELV (Forward phase/ leading edge) TRIAC dimmers, such as Lutron, Leviton, Crestron etc..

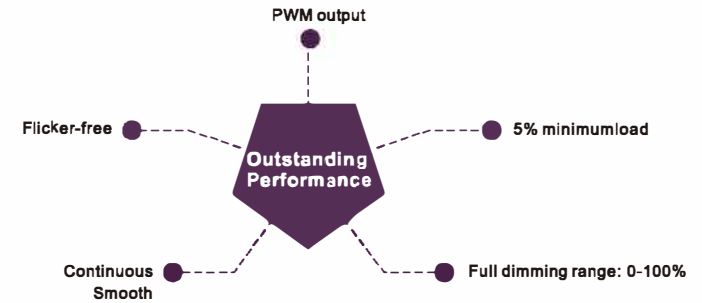

KVP different versions

KVP-xxxxx-TDL



25W-80W items:

For dry and damp location.

Class 2 power unit in low-profile compact plastic enclosure with terminal blocks enable easy and safe installation.

80W-200W Items:

For wet, dry and damp location.

Waterproof in compact aluminum enclosure (24V 80W 96W items are Class 2 unit).

Junction box



Low-profile aluminum enclosure with 6 knock-outs and input and output electrical cables enables easy installation

Model	for Dimmable LED Driver
J10, J12-5	25W50W models of KVP series
J12-1, J42-1, J42-2	60W models of KVP series
J5, J35-1, J35-2	80W-120W models of KVP series
J8, J38-1, J38-2	150W-200W models of KVP series

Perfect for LED fixtures

Perfect fit LED tape/strip, modules, LED bar light, cabinet light, kitchen light and other LED fixtures.









KVP Series

Triac/Phase-cut Dimming - Constant Voltage

Loading: 5-100% Dimming: 0-100% PWM Output











Power & Picture	Model	Output	Input	Certificate	Size	N.W.	Location
25W Class 2 	KVP-12025-TDL	12V, 2.1A	100-130 VAC	ETL, cETL, FCC, Class 2, RoHS	155*54*20mm	0.21kg	Dry, Damp
	KVP-24025-TDL	24V, 1.05A					
J10 J12-5 for choice							
50W Class 2 	KVP-12050-TDL	12V, 4.16A	100-130 VAC	ETL, cETL, FCC, Class 2, RoHS	178*61*24mm	0.35kg	Dry, Damp
	KVP-24050-TDL	24V, 2.1A					
J10 J12-5 for choice							
60W Class 2 	KVP-12060-TDL	12V, 5A	100-130 VAC	ETL, cETL, FCC, Class 2, RoHS	180*60*35mm	0.45kg	Dry, Damp
	KVP-24060-TDL	24V, 2.5A					
J12-1 for choice							
80W Class 2 	KVP-12080-TDL	12V, 6.67A	100-130 VAC	ETL, cETL, FCC, RoHS	230*70*43mm	1.05kg	Wet, Dry, Damp
	KVP-24080-TDL	24V, 3.33A		ETL, cETL, FCC, Class 2, RoHS			
96W Class 2 	KVP-24096-TDL	24V, 4A					
J5 for choice							
100W 	KVP-12100-TDL	12V, 8.33A	100-130 VAC	ETL, cETL, FCC, RoHS	230*70*43mm	1.05kg	Wet, Dry, Damp
	KVP-24100-TDL	24V, 4.16A					
J5 for choice							
120W 	KVP-12120-TDL	12V, 10A	100-130 VAC	ETL, cETL, FCC, RoHS	230*70*43mm	1.05kg	Wet, Dry, Damp
	KVP-24120-TDL	24V, 5A					
J5 for choice							
150W 	KVP-12150-TDL	12V, 12.5A	100-130 VAC	ETL, cETL, FCC, RoHS	256*78*47mm	1.45kg	Wet, Dry, Damp
	KVP-24150-TDL	24V, 6.25A					
J8 for choice							
200W 	KVP-12200-TDL	12V, 16.6A	100-130 VAC	ETL, cETL, FCC, RoHS	256*78*47mm	1.45kg	Wet, Dry, Damp
	KVP-24200-TDL	24V, 8.3A					
J8 for choice							

KV Series

Triac/Phase-cut Dimming - Constant Voltage

Loading: 60-100% Dimming: 0-100%







Power & Picture	Model	Output	Input	Certificate	Size	N.W.	Location
10W Class 2 	KV-12010-TDL	12V, 0.83A	100-130 VAC	ETL, cETL, FCC, Class 2, RoHS	A: 145*55*19.5mm B: 140*45*27mm	0.2kg	Dry, Damp
	KV-24010-TDL	24V, 0.42A					
	KV-36010-TDL	36V, 0.28A					
	KV-48010-TDL	48V, 0.21A					
ETL, FCC, Class 2, RoHS							
20W Class 2 	KV-12020-TDL	12V, 1.66A	100-130 VAC	ETL, cETL, FCC, Class 2, RoHS	A: 145*55*19.5mm B: 140*45*27mm	0.2kg	Dry, Damp
	KV-24020-TDL	24V, 0.83A					
	KV-36020-TDL	36V, 0.56A					
	KV-48020-TDL	48V, 0.42A					
ETL, FCC, Class 2, RoHS							
30W Class 2 	KV-12030-TDL	12V, 2.5A	100-130 VAC	ETL, cETL, FCC, Class 2, RoHS	180*60*35mm	0.45kg	Dry, Damp
	KV-24030-TDL	24V, 1.25A					
	KV-48030-TDL	48V, 0.63A					
ETL, FCC, Class 2, RoHS							
36W Class 2 	KV-12036-TDL	12V, 3A	100-130 VAC	ETL, cETL, FCC, Class 2, RoHS	180*60*35mm	0.45kg	Dry, Damp
	KV-24036-TDL	24V, 1.5A					
	KV-36036-TDL	36V, 1A					
	KV-48036-TDL	48V, 0.75A					
ETL, FCC, Class 2, RoHS							
45W Class 2 	KV-12045-TDL	12V, 3.75A	100-130 VAC	ETL, cETL, FCC, Class 2, RoHS	180*60*35mm	0.45kg	Dry, Damp
	KV-24045-TDL	24V, 1.87A					
	KV-36045-TDL	36V, 1.25A					
	KV-48045-TDL	48V, 0.94A					
ETL, FCC, Class 2, RoHS							
60W Class 2 	KV-12060-TDL	12V, 5A	100-130 VAC	ETL, cETL, FCC, Class 2, RoHS	200*70*43mm	0.95kg	Wet, Dry, Damp
	KV-24060-TDL	24V, 2.5A					
	KV-36060-TDL	36V, 1.67A					
ETL, FCC, Class 2, RoHS							
80W Class 2 	KV-12080-TDL	12V, 6.67A	100-130 VAC	ETL, cETL, FCC, Class 2, RoHS	200*70*43mm	0.95kg	Wet, Dry, Damp
	KV-24080-TDL	24V, 3.33A					
	KV-36080-TDL	36V, 2.22A					
ETL, FCC, Class 2, RoHS							
80W Class 2 	KV-48080-TDL	48V, 1.67A					
	J2 for choice						

KI Series

 **Class 2 RoHS**

Triac/Phase-cut Dimming - Constant Current

Dimming: 0-100%



Power & Picture	Model	Output	Input	Certificate	Size	N.W.	Location
10W Class 2 	KI-40250-TDL	24-40V 250mA	100-130 VAC	ETL, FCC, Class 2, RoHS	145*55*19.5mm	0.2kg	Dry, Damp
	KI-35350-TDL	20-35V 350mA		ETL, cETL, FCC, Class 2, RoHS			
	KI-20500-TDL	12-20V 500mA					
	KI-15700-TDL	9-15V 700mA					
20W Class 2 	KI-50350-TDL	30-50V 350mA	100-130 VAC	ETL, FCC, Class 2, RoHS	145*55*19.5mm	0.2kg	Dry, Damp
	KI-35500-TDL	21-35V 500mA		ETL, cETL, FCC, Class 2, RoHS			
	KI-25700-TDL	15-25V 700mA					
	KI-20900-TDL	12-20V 900mA					
30W Class 2 	KI-56500-TDL	32-56V 500mA	100-130 VAC	ETL, FCC, Class 2, RoHS	180*60*35mm	0.45kg	Dry, Damp
	KI-45700-TDL	25-45V 700mA		ETL, cETL, FCC, Class 2, RoHS			
	KI-36900-TDL	20-36V 900mA					
	KI-251200-TDL	15-25V 1200mA					
36W Class 2 	KI-56700-TDL	32-56V 700mA	100-130 VAC	ETL, FCC, Class 2, RoHS	180*60*35mm	0.45kg	Dry, Damp
	KI-42840-TDL	25-42V 840mA					
	KI-42900-TDL	25-42V 900mA					
	KI-381050-TDL	20-36V 1050mA		ETL, cETL, FCC, Class 2, RoHS			
	KI-251400-TDL	15-25V 1400mA					
	KI-201750-TDL	12-20V 1750mA					

KI Series

 **Class 2 RoHS**

Triac/Phase-cut Dimming - Constant Current

Dimming: 0-100%



Power & Picture	Model	Output	Input	Certificate	Size	N.W.	Location	
45W Class 2 	KI-56840-TDL	32-56V 840mA	100-130 VAC	ETL, FCC, Class 2, RoHS	180*60*35mm	0.45kg	Dry, Damp	
	KI-50900-TDL	30-50V 900mA						
	KI-451050-TDL	25-45V 1050mA						
	KI-421100-TDL	25-42V 1100mA						
	KI-381200-TDL	20-36V 1200mA						
	KI-321400-TDL	18-32V 1400mA						
	KI-251750-TDL	15-25V 1750mA						
	KI-202100-TDL	12-20V 2100mA						
60W Class 2  J2 for choice	KI-56900-TDL	32-56V 900mA	100-130 VAC	ETL, FCC, Class 2, RoHS	200*70*43mm	0.95kg	Wet, Dry, Damp	
	KI-561050-TDL	32-56V 1050mA						
	KI-451400-TDL	25-45V 1400mA						
	KI-381750-TDL	20-36V 1750mA						
	KI-302100-TDL	18-30V 2100mA						
	KI-252500-TDL	15-25V 2500mA						
	KI-202800-TDL	12-20V 2800mA						
	KI-203100-TDL	12-20V 3100mA						
80W Class 2  J2 for choice	KI-451750-TDL	25-45V 1750mA	100-130 VAC	ETL, FCC, Class 2, RoHS	200*70*43mm	0.95kg	Wet, Dry, Damp	
	KI-561400-TDL	32-56V 1400mA						
	KI-382100-TDL	20-36V 2100mA						
	KI-302500-TDL	18-30V 2500mA						
	KI-252800-TDL	15-25V 2800mA						
	KI-253100-TDL	15-25V 3100mA						

KIP Series - DIP Adjustment for multiple output current

CE RoHS

Triac/Phase-cut Dimming - Constant Current

Dimming: 0-100%

Power & Picture	Model	Output	Input	Certificate	Size	N.W.	Location
15W 	KIP-015-TDL DIP Adjustment (Multi-current)	20-50V 150mA ○○○	100-130 VAC	CE, RoHS	140*45*27mm	0.15kg	Dry, Damp
		5-50V 250mA ●○○					
		5-45V 350mA ○○●					
		5-38V 400mA ○○○					
		5-35V 450mA ●●●					
		5-30V 500mA ●●○					
		5-25V 600mA ○●●					
		5-22V 700mA ●●●					
25W 	KIP-025-TDL DIP Adjustment (Multi-current)	5-50V 300mA ○○○	100-130 VAC	CE, RoHS	155*54*20mm	0.21kg	Dry, Damp
		5-50V 350mA ●○○					
		5-50V 500mA ○○●					
		5-45V 550mA ●●●					
		5-38V 650mA ○○○					
		5-35V 700mA ●●○					
		5-30V 850mA ○●●					
		5-28V 900mA ●●●					
50W 	KIP-050-TDL DIP Adjustment (Multi-current)	10-50V 700mA ○○○	100-130 VAC	CE, RoHS	178*61*24mm	0.35kg	Dry, Damp
		10-50V 850mA ○●○					
		10-50V 900mA ○○●					
		10-48V 1050mA ○●●					
		10-43V 1150mA ●○○					
		10-40V 1250mA ●●○					
		10-38V 1300mA ●●●					
		10-36V 1400mA ●●●					

PART 2

Triac/ Phase-cut & 0/1-10V & 10V PWM & Potentiometer (5 in 1) Dimmable LED Driver Series

(For LED strip, light bar, LED module, panel, down light and other LED light)



Wiring diagram

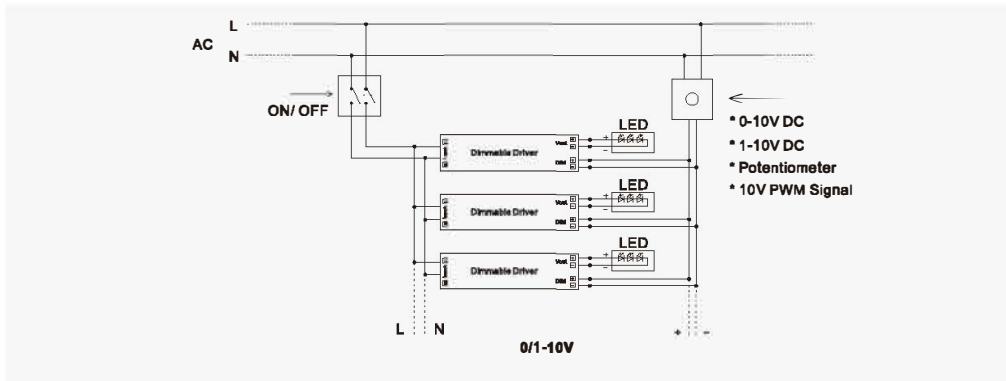
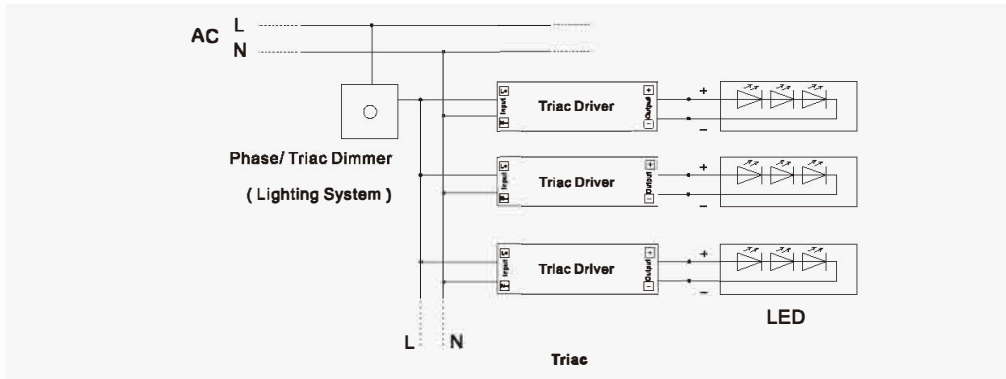
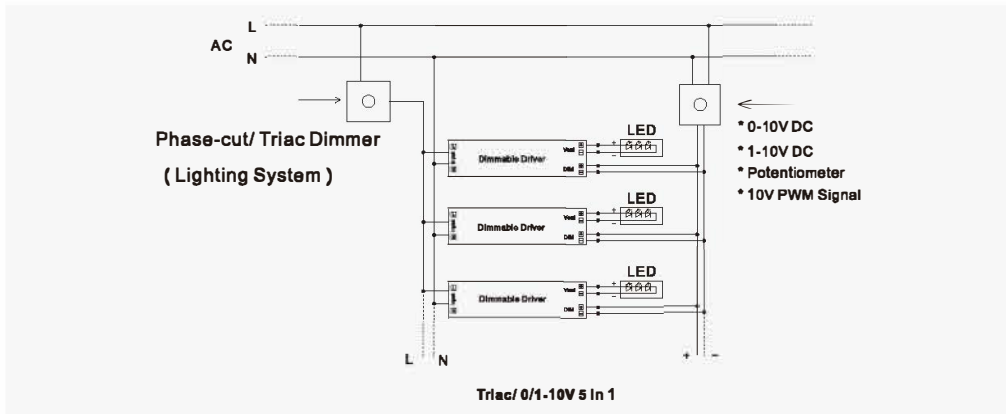

KVG Series

Class 2 Class P TYPE HL RoHS

Triac/ Phase-cut & 0-10V (5 in 1) Dimming - Constant Voltage

for **120V&277V dimmer**

PF > 0.95 Loading: 10-100% Dimming: 0-100% 5 years warranty PWM Output

Overview

CERULEAN'S PWM AC Phase cut(Triac)/ 0-10V/ 1-1 0V / Potentiometer/ 1 0V PWM (5 in 1) compatible solution dimmable driver, making it easy for projects and simplify the inventory.

They are compatible with a wide array of popular dimmers, including CFL/LED, ELV and MLV types of TRIAC dimmers, 0-1 0V| 1-1 0V| 1 00K potentiometer |1 0V PWM dimmer and various lighting control system, such as Lutron, Leviton, Crestron, etc. This makes the drivers easy to integrate into existing lighting installations.

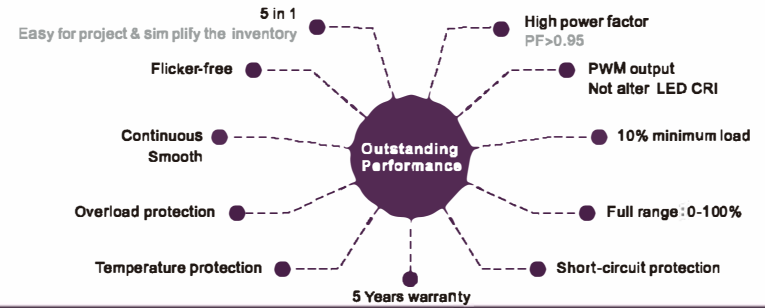

Different versions

KVG-xxxxx-DW



30W-60W items:
Plastic enclosure for dry and damp location

80W-300W items:
Compact aluminum enclosure for wet, dry and damp location

KVG-xxxxx-DWS&DWL



30W-100W items:
DWS in plastic for dry and damp location
DWL in Metal for wet, dry and damp location

KVG-xxxxx-DWJ&DWJV5



30W-300W items:
Dimmable LED Driver built-in Junction box

KVG-xxxxx-DWJV2



30W-300W items:
Dimmable LED Driver with Junction box

KVG-Cxxxxx-DW&DWJ&DWJV2



180W-384W items:
Multiple independent output groups.
High wattage driver but still Class 2 unit

KVG-xxxxx-DWR



60W-100W items:
Dimmable din rail driver

Perfect to use for LED fixtures

Perfect to use for LED tape/strip, modules, LED bar light, cabinet light, kitchen light and other LED fixtures.



KVG Series

Class 2 Class P TYPE HL RoHS

Triac/ Phase-cut & 0-10V (5 in 1) Dimming - Constant Voltage

for 120V&277V dimmer

PF > 0.95

Loading: 10-100% Dimming: 0-100%

PWM output

Power & Picture	Model	Output	Input	Certificate	Size	N.W.	Location					
30W Class 2	KVG-12030-DWS	12V, 2.5A	100-277 VAC	UL, cUL, FCC Pending Class 2, RoHS	280*30*18.5mm	0.2kg	Dry, Damp					
	KVG-24030-DWS	24V, 1.25A										
	KVG-12030-DWL	12V, 2.5A										
	KVG-24030-DWL	24V, 1.25A										
	KVG-12030-DW	10-13V, 2.5A		UL, cUL, FCC Pending Class 2, RoHS	155*54*20mm	0.21kg	Dry, Damp					
		KVG-24030-DW						21.5-25.5V, 1.25A				
		KVG-12030-DWJ						12V, 2.5A	UL, cUL, FCC Pending Class 2, RoHS	185*92*41mm	0.95kg	Wet, Dry, Damp
								KVG-24030-DWJ				
		KVG-12030-DWJV5						12V, 2.5A	UL, cUL, FCC Pending Class 2, RoHS	185*112*26mm	1.05kg	Dry, Damp
								KVG-24030-DWJV5				
	KVG-12030-DWJV2	10-13V, 2.5A		UL, cUL, FCC Pending Class 2, RoHS	J10: 350*77*26mm J12-5: 350*77*37mm	J10: 0.7kg J12-5: 0.8kg	Dry, Damp					
		KVG-24030-DWJV2						21.5-25.5V, 1.25A				
36W Class 2	KVG-12036-DWS	12V, 3A	100-277 VAC	UL, cUL, FCC Pending Class 2, RoHS	260*30*18.5mm	0.2kg	Dry, Damp					
	KVG-24036-DWS	24V, 1.5A										
	KVG-12036-DWL	12V, 3A										
	KVG-24036-DWL	24V, 1.5A										
60W Class 2	KVG-12060-DWS	12V, 5A	100-277 VAC	UL, cUL, FCC Pending Class 2, RoHS	300*30*18.5mm	0.3kg	Dry, Damp					
	KVG-24060-DWS	24V, 2.5A										
	KVG-12060-DWL	12V, 5A		UL, cUL, FCC Pending Class 2, RoHS	300*32*20mm	0.45kg	Wet, Dry, Damp					
		KVG-24060-DWL						24V, 2.5A				
	KVG-12080-DW	10-13V, 5A		UL, cUL, FCC Pending Class 2, RoHS	178*61*24mm	0.35kg	Dry, Damp					
		KVG-24080-DW						21.5-25.5V, 2.5A				
	KVG-12080-DWJ	12V, 5A		UL, cUL, FCC Pending Class 2, RoHS	188*92*41mm	1.1kg	Wet, Dry, Damp					
		KVG-24060-DWJ						24V, 2.5A				
	KVG-12060-DWJV5	12V, 2.5A		UL, cUL, FCC Pending Class 2, RoHS	188*112*26mm	1.2kg	Dry, Damp					
		KVG-24060-DWJV5						24V, 1.25A				
	KVG-12080-DWJV2	10-13V, 5A		UL, cUL, FCC Pending Class 2, RoHS	J10: 350*77*26mm J12-5: 350*77*37mm	J10: 0.81kg J12-5: 0.9kg	Dry, Damp					
		KVG-24060-DWJV2						21.5-25.5V, 2.5A				

Note: These drivers with slightly adjustable output voltage as below:

KVG-12030-DW KVG-12060-DW output voltage: 10-13V

KVG-12030-DWV2 KVG-12060-DWV2 output voltage: 10-13V

KVG-24030-DW KVG-24060-DW output voltage: 21.5-25.5V

KVG-24030-DWV2 KVG-24060-DWV2 output voltage: 21.5-25.5V

KVG Series

Class 2 Class P TYPE HL RoHS

Triac/ Phase-cut & 0-10V (5 In 1) Dimming - Constant Voltage

for 120V&277V dimmer

PF > 0.95

Loading: 10-100% Dimming: 0-100%

PWM output

Power & Picture	Model	Output	Input	Certificate	Size	N.W.	Location				
80W Class 2	KVG-12080-DW	12V, 6.67A	100-277 VAC	UL, cUL, FCC Pending Class 2, RoHS	230*70*43mm	1.1kg	Wet, Dry, Damp				
	KVG-24080-DW	24V, 3.33A									
	KVG-12080-DWJ	12V, 6.67A		UL, cUL, FCC Pending Class 2, RoHS	220*93*41mm	1.3kg	Wet, Dry, Damp				
		KVG-24080-DWJ						24V, 3.33A			
	KVG-12080-DWJV2	12V, 6.67A		UL, cUL, FCC Pending Class 2, RoHS	380*77*57mm	1.8kg	Dry, Damp				
		KVG-24080-DWJV2						24V, 3.33A			
	96W Class 2	KVG-24096-DWS		24V, 4A	100-277 VAC	UL, cUL, FCC Pending Class 2, RoHS	330*30*22mm	0.4kg	Dry, Damp		
		KVG-24096-DWL		24V, 4A							
KVG-24096-DW		24V, 4A	UL, cUL, FCC Pending Class 2, RoHS	230*70*43mm						1.1kg	Wet, Dry, Damp
		KVG-24096-DWJ									
KVG-24096-DWJV2		24V, 4A	UL, cUL, FCC Pending Class 2, RoHS	380*77*57mm						1.8kg	Dry, Damp
		KVG-24096-DWJV2									
100W	KVG-12100-DWS	12V, 8.33A	100-277 VAC	UL, cUL, FCC Pending RoHS	330*30*22mm	0.4kg	Dry, Damp				
	KVG-24100-DWS	24V, 4.17A									
	KVG-12100-DWL	12V, 8.33A		UL, cUL, FCC Pending RoHS	330*32*23mm	0.55kg	Wet, Dry, Damp				
		KVG-24100-DWL						24V, 4.17A			
	KVG-12100-DW	12V, 8.33A		UL, cUL, FCC Pending RoHS	230*70*43mm	1.1kg	Wet, Dry, Damp				
		KVG-24100-DW						24V, 4.17A			
	KVG-12100-DWJ	12V, 8.33A		UL, cUL, FCC Pending RoHS	220*93*41mm	1.3kg	Wet, Dry, Damp				
		KVG-24100-DWJ						24V, 4.17A			
KVG-12100-DWJV2	12V, 8.33A	UL, cUL, FCC Pending RoHS	380*77*57mm	1.8kg	Dry, Damp						
	KVG-24100-DWJV2					24V, 4.17A					

KVG Series

  Class 2 Class P TYPE HL RoHS

Triac/ Phase-cut & 0-10V (5 In 1) Dimming - Constant Voltage

for 120V&277V dimmer

PF > 0.95 Loading: 10-100% Dimming: 0-100%

PWM output

Class 2 Multiple Output

Power & Picture	Model	Output	Input	Certificate	Size	N.W.	Location
120W	 KVG-12120-DW	12V, 10A	100-277 VAC	UL, cUL, FCC Pending RoHS	230*70*43mm	1.1kg	Wet, Dry, Damp
	KVG-24120-DW	24V, 5A					
	 KVG-12120-DWJ	12V, 10A		UL, cUL, FCC Pending RoHS	220*93*41mm	1.3kg	Wet, Dry, Damp
	KVG-24120-DWJ	24V, 5A					
	 KVG-12120-DWJV2	12V, 8.33A		UL, cUL, FCC Pending RoHS	380*77*57mm	1.8kg	Dry, Damp
	KVG-24120-DWJV2	24V, 4.17A					
150W	 KVG-12150-DW	12V, 12.5A	100-277 VAC	UL, cUL, FCC Pending RoHS	256*78*47mm	1.45kg	Wet, Dry, Damp
	KVG-24150-DW	24V, 6.25A					
	 KVG-12150-DWJ	12V, 12.5A		UL, cUL, FCC Pending RoHS	260*103*48mm	1.8kg	Wet, Dry, Damp
	KVG-24150-DWJ	24V, 6.25A					
	 KVG-12150-DWJV2	12V, 12.5A		UL, cUL, FCC Pending RoHS	406*87*60mm	2.2kg	Dry, Damp
	KVG-24150-DWJV2	24V, 6.25A					
180W Class 2	 KVG-C12180-DW (MULTI 3x60W)	12V, MULTI 3x5A	100-277 VAC	UL, cUL, FCC Pending Class2, RoHS	276*78*47mm	1.7kg	Wet, Dry, Damp
	 KVG-C12180-DWJ (MULTI 3x60W)	12V, MULTI 3x5A		UL, cUL, FCC Pending Class2, RoHS	278*108*48mm	2.0kg	Wet, Dry, Damp
	 KVG-C12180-DWJV2 (MULTI 3x60W)	12V, MULTI 3x5A		UL, cUL, FCC Pending Class2, RoHS	455*87*60mm	2.5kg	Dry, Damp
182W Class 2	 KVG-C24192-DW (MULTI 2x96W)	24V, MULTI 2x4A	100-277 VAC	UL, cUL, FCC Pending Class2, RoHS	276*78*47mm	1.7kg	Wet, Dry, Damp
	 KVG-C24192-DWJ (MULTI 2x96W)	24V, MULTI 2x4A		UL, cUL, FCC Pending Class2, RoHS	278*108*46mm	2.5kg	Wet, Dry, Damp
	 KVG-C24192-DWJV2 (MULTI 2x96W)	24V, MULTI 2x4A		UL, cUL, FCC Pending Class2, RoHS	455*87*60mm	2.5kg	Dry, Damp
200W	 KVG-12200-DW	12V, 16.67A	100-277 VAC	UL, cUL, FCC Pending RoHS	256*78*47mm	1.5kg	Wet, Dry, Damp
	KVG-24200-DW	24V, 8.33A					
	 KVG-12200-DWJ	12V, 16.67A		UL, cUL, FCC Pending RoHS	260*103*46mm	1.8kg	Wet, Dry, Damp
	KVG-24200-DWJ	24V, 8.33A					

KVG Series

  Class 2 Class P TYPE HL RoHS

Triac/ Phase-cut & 0-10V (5 in 1) Dimming - Constant Voltage

for 120V&277V dimmer

PF > 0.95 Loading: 10-100% Dimming: 0-100%

PWM output

Class 2 Multiple Output

Power & Picture	Model	Output	Input	Certificate	Size	N.W.	Location
200W	 KVG-12200-DWJV2	12V, 16.67A	100-277 VAC	UL, cUL, FCC Pending RoHS	406*87*60mm	2.3kg	Dry, Damp
	KVG-24200-DWJV2	24V, 8.33A					
288W Class 2	 KVG-C24288-DW (MULTI 3x96W)	24V, MULTI 3x4A	100-277 VAC	UL, cUL, FCC Pending Class2, RoHS	301*78*47mm	1.9kg	Wet, Dry, Damp
	 KVG-C24288-DWJ (MULTI 3x96W)	24V, MULTI 3x4A		UL, cUL, FCC Pending Class2, RoHS	301*108*46mm	2.2kg	Wet, Dry, Damp
	 KVG-C24288-DWJV2 (MULTI 3x96W)	24V, MULTI 3x4A		UL, cUL, FCC Pending Class2, RoHS	455*87*80mm	2.7kg	Dry, Damp
	 KVG-12300-DW	12V, 25A		UL, cUL, FCC Pending RoHS	276*78*47mm	1.7kg	Wet, Dry, Damp
KVG-24300-DW	24V, 12.5A						
300W	 KVG-12300-DWJ	12V, 25A	100-277 VAC	UL, cUL, FCC Pending RoHS	278*108*46mm	2.0kg	Wet, Dry, Damp
	KVG-24300-DWJ	24V, 12.5A					
	 KVG-12300-DWJV2	12V, 25A		UL, cUL, FCC Pending RoHS	455*87*80mm	2.5kg	Dry, Damp
	KVG-24300-DWJV2	24V, 12.5A					
300W Class 2	 KVG-C12300-DW (MULTI 5x80W)	12V, MULTI 5x5A	100-277 VAC	UL, cUL, FCC Pending Class2, RoHS	301*78*47mm	1.9kg	Wet, Dry, Damp
	 KVG-C12300-DWJ (MULTI 5x80W)	12V, MULTI 5x5A		UL, cUL, FCC Pending Class2, RoHS	301*108*46mm	2.2kg	Wet, Dry, Damp
	 KVG-C12300-DWJV2 (MULTI 5x80W)	12V, MULTI 5x5A		UL, cUL, FCC Pending Class2, RoHS	455*87*80mm	2.5kg	Dry, Damp
	 KVG-C24384-DW (MULTI 4x96W)	24V, MULTI 4x4A		UL, cUL, FCC Pending Class2, RoHS	322*78*47mm	2kg	Wet, Dry, Damp
KVG-C48384-DW (MULTI 4x96W)	48V, MULTI 4x2A						
384W Class 2	 KVG-C24384-DWJ (MULTI 4x96W)	24V, MULTI 4x4A	100-277 VAC	UL, cUL, FCC Pending Class2, RoHS	327*108*46mm	2.4kg	Wet, Dry, Damp
	 KVG-C48384-DWJ (MULTI 4x96W)	48V, MULTI 4x2A					

KVG Series



- Din Rail LED Driver

  Class 2 Class P TYPE HL RoHS

Triac/ Phase-cut & 0-10V (5 in 1) Dimming - Constant Voltage

PF > 0.95 Loading: 10-100% Dimming: 0-100%

for 120V&277V dimmer

Power & Picture	Model	Output	Input	Certificate	Size	N.W.	Location
60W 	KVG-12060-DWR	12V, 5A	100-277 VAC	UL, cUL, FCC Pending Class2, RoHS	40*90*100mm	0.3kg	Dry, Damp
	KVG-24060-DWR	24V, 2.5A		UL, cUL, FCC Pending Class2, RoHS	40*90*100mm	0.3kg	Dry, Damp
96W 	KVG-24096-DWR	24V, 4A	100-277 VAC	UL, cUL, FCC Pending Class2, RoHS	55*90*100mm	0.4kg	Dry, Damp
100W 	KVG-12100-DWR	12V, 8.33A	100-277 VAC	UL, cUL, FCC Pending, RoHS	55*90*100mm	0.4kg	Dry, Damp
	KVG-24100-DWR	24V, 4.17A		UL, cUL, FCC Pending, RoHS	55*90*100mm	0.4kg	Dry, Damp

PART 3

0/1-10V & 10V PWM & Potentiometer (4 in 1) Dimmable LED Driver Series

(For LED strip, light bar, LED module, panel, down light and other LED light)

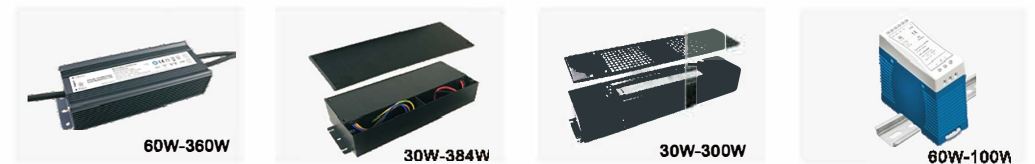

Wiring diagram

Diagram 1

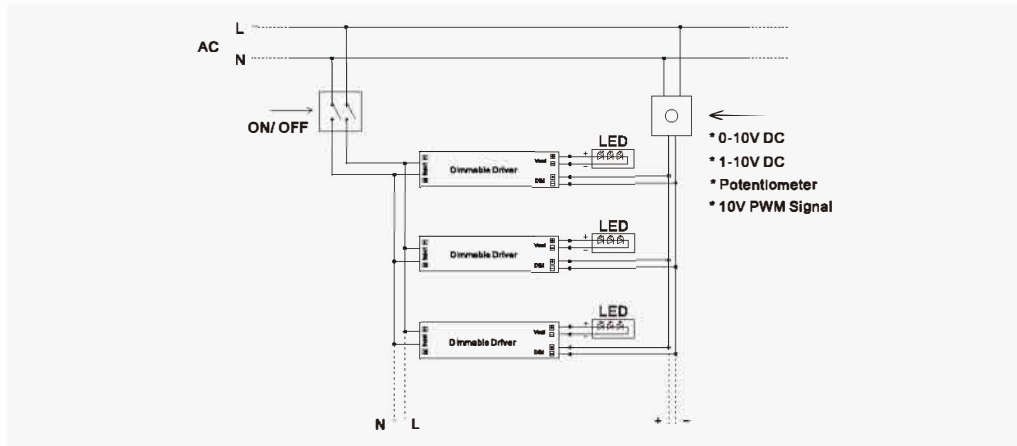
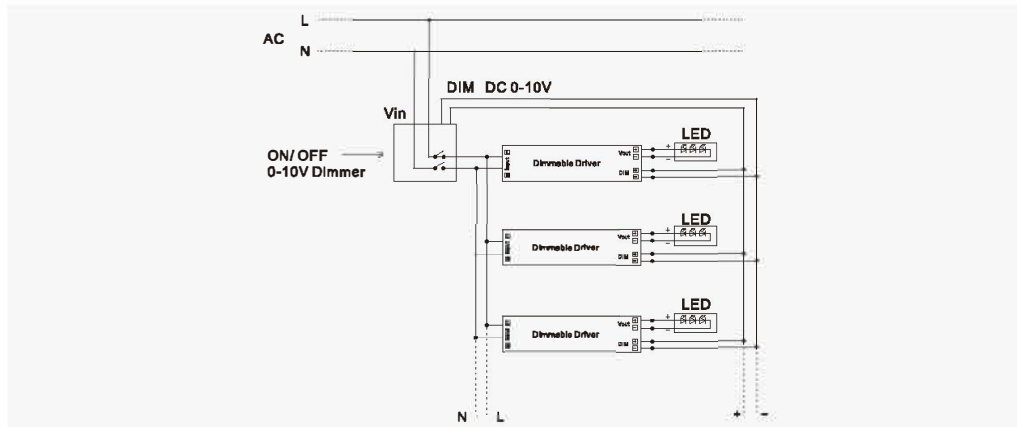

Diagram 2



0-10V Dimmer
Model : KLD-0-10



1-10V Dimmer
Model : KLD-1-10

0-10V/1-10V/Potentiometer/10V PWM (4 in 1) Dimming LED Driver Series



Overview

CERULEAN'S 0-10V/1-10V/potentiometer/ 10V PWM (4 In 1) dimmable driver include C.V. 10-384W, C.C. 10-200W, and C.C. DIP adjustment 20W&50W optional output current which could be set by users via DIP switch to fit the corresponding led fixture.

0-10V 4 in 1 driver is compatible with all standard 0-10V/1-10V/100K potentiometer/10V PWM dimmer and various lighting control system, such as Lutron, Clispal, C-bus etc. The driver provides smooth, no flicker 0-100% full dimming range and stepless dimming performance.

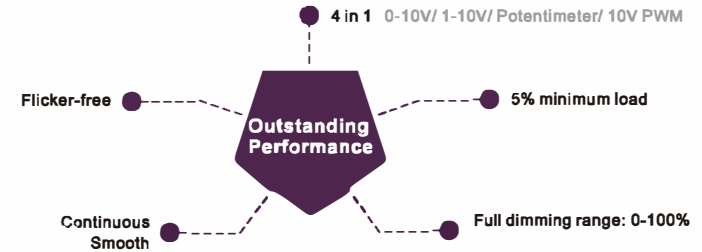

KV/KVD-xxxx-DIM



10W-60W items:
Plastic enclosure for dry and damp location
80W-300W items:

KV/KVD/KI-xxxx-DIM



20W-36W items:
Linear aluminum enclosure for outdoor waterproof use (IP 66).
60W-360W items:
Compact aluminum enclosure for wet, dry and damp location

KVD-xxxx-DIMR



60W-100W items:
Dimmable din rail driver

KVD-xxxx-DIMS&DIML



30W-100W items:
DIMS in plastic for dry and damp location
DIML in Metal for dry, damp and wet location

KVD-xxxx-DIMJ&DIMJV2&DIMJV5

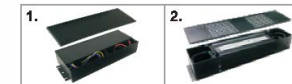

1. 30W-300W items:
Dimmable LED Driver built-in Junction box
2. 30W-300W items:
Dimmable LED Driver with Junction box

KVD-Cxxxx-DIM&DIMJ



180W-384W items:
Multiple independent output groups
High wattage driver but still Class 2 unit

Perfect to use for LED fixtures

Perfect to use for LED tape/strip, modules, LED bar light, cabinet light, kitchen light and other LED fixtures.







KVD Series

0/1-10V (4 in 1) Dimming - Constant Voltage

PF > 0.95 Dimming: 0-100%

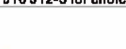

for 120V&277V dimmer

Power & Picture	Model	Output	Input	Certificate	Size	N.W.	Location		
30W Class 2	 KVD-12030-DIMS	12V, 2.5A	100-277VAC	UL, cUL, FCC Pending Class 2, RoHS	260*30*18.5mm	0.2kg	Dry, Damp		
	 KVD-24030-DIMS	24V, 1.25A							
	 KVD-12030-DIML	12V, 2.5A							
	 KVD-24030-DIML	24V, 1.25A							
	 KVD-12030-DIM	10-13V, 2.5A		UL, cUL, FCC Pending Class 2, RoHS	155*54*20mm	0.21kg	Dry, Damp		
	 KVD-24030-DIM	21.5-25.5V, 1.25A							
	 KVD-12030-DIMJ	12V, 2.5A							
	 KVD-24030-DIMJ	24V, 1.25A							
	 KVD-12030-DIMJV5	12V, 2.5A		UL, cUL, FCC Pending Class 2, RoHS	165*112*26mm	1.05kg	Dry, Damp		
	 KVD-24030-DIMJV5	24V, 1.25A							
	 KVD-12030-DIMJV2	12V, 2.5A							
	 KVD-24030-DIMJV2	24V, 1.25A							
36W Class 2	 KVD-12036-DIMS	12V, 3A	100-277 VAC	UL, cUL, FCC Pending Class 2, RoHS	260*30*18.5mm	0.2kg	Dry, Damp		
	 KVD-24036-DIMS	24V, 1.5A							
	 KVD-12036-DIML	12V, 3A							
	 KVD-24036-DIML	24V, 1.5A							
60W Class 2	 KVD-12060-DIMS	12V, 5A	100-277 VAC	UL, cUL, FCC Pending Class 2, RoHS	300*30*18.5mm	0.3kg	Dry, Damp		
	 KVD-24060-DIMS	24V, 2.5A							
	 KVD-12060-DIML	12V, 5A							
	 KVD-24060-DIML	24V, 2.5A							
	 KVD-12060-DIM	10-13V, 5A		UL, cUL, FCC Pending Class 2, RoHS	178*61*24mm	0.35kg	Dry, Damp		
	 KVD-24060-DIM	21.5-25.5V, 2.5A							
	 KVD-12060-DIMJ	12V, 5A							
	 KVD-24060-DIMJ	24V, 2.5A							
	 KVD-12060-DIMJV5	12V, 2.5A		UL, cUL, FCC Pending Class 2, RoHS	188*92*41mm	1.1kg	Wet, Dry, Damp		
	 KVD-24060-DIMJV5	24V, 1.25A							
	 KVD-12060-DIMJV2	12V, 2.5A							
	 KVD-24060-DIMJV2	24V, 1.25A							
80W Class 2	 KVD-12080-DIM	12V, 6.67A	100-277 VAC	UL, cUL, FCC Pending Class 2, RoHS	230*70*43mm	1.1kg	Wet, Dry, Damp		
	 KVD-24080-DIM	24V, 3.33A							
	 KVD-12080-DIMJ	12V, 6.67A							
	 KVD-24080-DIMJ	24V, 3.33A							
	 KVD-12080-DIMJV2	12V, 6.67A		UL, cUL, FCC Pending Class 2, RoHS	220*93*41mm	1.3kg	Wet, Dry, Damp		
	 KVD-24080-DIMJV2	24V, 3.33A							
	 KVD-12080-DIMJV2	12V, 6.67A							
	 KVD-24080-DIMJV2	24V, 3.33A							
	96W Class 2	 KVD-24096-DIMS		24V, 4A	100-277 VAC	UL, cUL, FCC Pending Class 2, RoHS	330*30*22mm	0.4kg	Dry, Damp
		 KVG-24096-DIML		24V, 4A					
		 KVD-24096-DIM		24V, 4A					
		 KVD-24096-DIMJ		24V, 4A					
 KVD-24096-DIMJV2		24V, 4A							
 KVD-24096-DIMJV2		24V, 4A							
100W	 KVD-12100-DIMS	12V, 8.33A	100-277 VAC	UL, cUL, FCC Pending RoHS	330*30*22mm	0.4kg	Dry, Damp		
	 KVD-24100-DIMS	24V, 4.17A							
	 KVD-12100-DIML	12V, 8.33A							
	 KVD-24100-DIML	24V, 4.17A							
	 KVD-12100-DIM	12V, 8.33A		UL, cUL, FCC Pending RoHS	230*70*43mm	1.1kg	Wet, Dry, Damp		
	 KVD-24100-DIM	24V, 4.17A							
	 KVD-12100-DIMJ	12V, 8.33A							
	 KVD-24100-DIMJ	24V, 4.17A							
	 KVD-12100-DIMJV2	12V, 8.33A		UL, cUL, FCC Pending RoHS	220*93*41mm	1.3kg	Wet, Dry, Damp		
	 KVD-24100-DIMJV2	24V, 4.17A							
	 KVD-12100-DIMJV2	12V, 8.33A							
	 KVD-24100-DIMJV2	24V, 4.17A							



























KVD Series

0/1-10V (4 in 1) Dimming - Constant Voltage

PF > 0.95 Dimming: 0-100%



for 120V&277V dimmer

Power & Picture	Model	Output	Input	Certificate	Size	N.W.	Location		
80W Class 2	 KVD-12080-DIM	12V, 6.67A	100-277 VAC	UL, cUL, FCC Pending RoHS	230*70*43mm	1.1kg	Wet, Dry, Damp		
	 KVD-24080-DIM	24V, 3.33A							
	 KVD-12080-DIMJ	12V, 6.67A							
	 KVD-24080-DIMJ	24V, 3.33A							
	 KVD-12080-DIMJV2	12V, 6.67A		UL, cUL, FCC Pending Class 2, RoHS	220*93*41mm	1.3kg	Wet, Dry, Damp		
	 KVD-24080-DIMJV2	24V, 3.33A							
	 KVD-12080-DIMJV2	12V, 6.67A							
	 KVD-24080-DIMJV2	24V, 3.33A							
	96W Class 2	 KVD-24096-DIMS		24V, 4A	100-277 VAC	UL, cUL, FCC Pending Class 2, RoHS	330*30*22mm	0.4kg	Dry, Damp
		 KVG-24096-DIML		24V, 4A					
		 KVD-24096-DIM		24V, 4A					
		 KVD-24096-DIMJ		24V, 4A					
 KVD-24096-DIMJV2		24V, 4A							
 KVD-24096-DIMJV2		24V, 4A							
100W	 KVD-12100-DIMS	12V, 8.33A	100-277 VAC	UL, cUL, FCC Pending RoHS	330*30*22mm	0.4kg	Dry, Damp		
	 KVD-24100-DIMS	24V, 4.17A							
	 KVD-12100-DIML	12V, 8.33A							
	 KVD-24100-DIML	24V, 4.17A							
	 KVD-12100-DIM	12V, 8.33A		UL, cUL, FCC Pending RoHS	230*70*43mm	1.1kg	Wet, Dry, Damp		
	 KVD-24100-DIM	24V, 4.17A							
	 KVD-12100-DIMJ	12V, 8.33A							
	 KVD-24100-DIMJ	24V, 4.17A							
	 KVD-12100-DIMJV2	12V, 8.33A		UL, cUL, FCC Pending RoHS	220*93*41mm	1.3kg	Wet, Dry, Damp		
	 KVD-24100-DIMJV2	24V, 4.17A							
	 KVD-12100-DIMJV2	12V, 8.33A							
	 KVD-24100-DIMJV2	24V, 4.17A							

KVD Series

0/1-10V (4 in 1) Dimming - Constant Voltage

PF > 0.95 Dimming: 0-100%



for 120V&277V dimmer

Class 2 Multiple Output

Power & Picture	Model	Output	Input	Certificate	Size	N.W.	Location	
120W	 KVD-12120-DIM	12V, 10A	100-277 VAC	UL, cUL, FCC Pending RoHS	230*70*43mm	1.1kg	Wet, Dry, Damp	
	KVD-24120-DIM	24V, 5A						
	 KVD-12120-DIMJ	12V, 10A		UL, cUL, FCC Pending RoHS	220*93*41mm	1.3kg	Wet, Dry, Damp	
	KVD-24120-DIMJ	24V, 5A						
	 With J5	KVD-12120-DIMJV2		12V, 8.33A	UL, cUL, FCC Pending RoHS	380*77*57mm	1.8kg	Dry, Damp
	KVD-24120-DIMJV2	24V, 4.17A						
150W	 KVD-12150-DIM	12V, 12.5A	100-277 VAC	UL, cUL, FCC Pending RoHS	256*78*47mm	1.45kg	Wet, Dry, Damp	
	KVD-24150-DIM	24V, 6.25A						
	 KVD-12150-DIMJ	12V, 12.5A		UL, cUL, FCC Pending RoHS	260*103*46mm	1.8kg	Wet, Dry, Damp	
	KVD-24150-DIMJ	24V, 6.25A						
	 With J6	KVD-12150-DIMJV2		12V, 12.5A	UL, cUL, FCC Pending RoHS	408*87*60mm	2.2kg	Dry, Damp
	KVD-24150-DIMJV2	24V, 6.25A						
180W Class 2	 KVD-C12180-DIM (MULTI 3*60W)	12V, MULTI 3*5A	100-277 VAC	UL, cUL, FCC Pending Class2, RoHS	276*78*47mm	1.7kg	Wet, Dry, Damp	
	 KVD-C12180-DIMJ (MULTI 3*60W)	12V, MULTI 3*5A		UL, cUL, FCC Pending Class2, RoHS	278*108*46mm	2.0kg	Wet, Dry, Damp	
	 With J9	KVD-C12180-DIMJV2 (MULTI 3*60W)		12V, MULTI 3*5A	UL, cUL, FCC Pending Class2, RoHS	455*87*60mm	2.5kg	Dry, Damp
182W Class 2	 KVD-C24192-DIM (MULTI 2*96W)	24V, MULTI 2*4A	100-277 VAC	UL, cUL, FCC Pending Class2, RoHS	278*78*47mm	1.7kg	Wet, Dry, Damp	
	 KVD-C24192-DIMJ (MULTI 2*96W)	24V, MULTI 2*4A		UL, cUL, FCC Pending Class2, RoHS	278*108*46mm	2.5kg	Wet, Dry, Damp	
	 With J3	KVD-C24192-DIMJV2 (MULTI 2*96W)		24V, MULTI 2*4A	UL, cUL, FCC Pending Class2, RoHS	455*87*60mm	2.5kg	Dry, Damp
200W	 KVD-12200-DIM	12V, 16.67A	100-277 VAC	UL, cUL, FCC Pending RoHS	256*78*47mm	1.5kg	Wet, Dry, Damp	
	KVD-24200-DIM	24V, 8.33A						
	 KVD-12200-DIMJ	12V, 16.67A		UL, cUL, FCC Pending RoHS	260*103*46mm	1.8kg	Wet, Dry, Damp	
	KVD-24200-DIMJ	24V, 8.33A						

KVD Series

0/1-10V (4 in 1) Dimming - Constant Voltage

PF > 0.95 Dimming: 0-100%



for 120V&277V dimmer

Class 2 Multiple Output

Power & Picture	Model	Output	Input	Certificate	Size	N.W.	Location	
200W	 With J8	KVD-12200-DIMJV2	12V, 16.67A	UL, cUL, FCC Pending RoHS	408*87*60mm	2.3kg	Dry, Damp	
	KVD-24200-DIMJV2	24V, 8.33A						
288W Class 2	 KVD-C24288-DIM (MULTI 3*96W)	24V, MULTI 3*4A	100-277 VAC	UL, cUL, FCC Pending Class2, RoHS	301*78*47mm	1.9kg	Wet, Dry, Damp	
	 KVD-C24288-DIMJ (MULTI 3*96W)	24V, MULTI 3*4A		UL, cUL, FCC Pending Class2, RoHS	301*108*46mm	2.2kg	Wet, Dry, Damp	
	 KVD-C24288-DIMJV2 (MULTI 3*96W)	24V, MULTI 3*4A		UL, cUL, FCC Pending Class2, RoHS	455*87*60mm	2.7kg	Dry, Damp	
300W	 KVD-12300-DIM	12V, 25A	100-277 VAC	UL, cUL, FCC Pending RoHS	276*78*47mm	1.7kg	Wet, Dry, Damp	
	KVD-24300-DIM	24V, 12.5A						
	 KVD-12300-DIMJ	12V, 25A		UL, cUL, FCC Pending RoHS	278*108*46mm	2.0kg	Wet, Dry, Damp	
	KVD-24300-DIMJ	24V, 12.5A						
	 With J30	KVD-12300-DIMJV2		12V, 25A	UL, cUL, FCC Pending RoHS	455*87*60mm	2.5kg	Dry, Damp
	KVD-24300-DIMJV2	24V, 12.5A						
300W Class 2	 KVD-C12300-DIM (MULTI 5*60W)	12V, MULTI 5*5A	100-277 VAC	UL, cUL, FCC Pending Class2, RoHS	301*78*47mm	1.9kg	Wet, Dry, Damp	
	 KVD-C12300-DIMJ (MULTI 5*60W)	12V, MULTI 5*5A		UL, cUL, FCC Pending Class2, RoHS	301*108*46mm	2.2kg	Wet, Dry, Damp	
	 With J30	KVD-C12300-DIMJV2 (MULTI 5*60W)		12V, MULTI 5*5A	UL, cUL, FCC Pending Class2, RoHS	455*87*60mm	2.5kg	Dry, Damp
	KVD-C24384-DIM (MULTI 4*96W)	24V, MULTI 4*4A		UL, cUL, FCC Pending Class2, RoHS	322*78*47mm	2kg	Wet, Dry, Damp	
KVD-C48384-DIM (MULTI 4*96W)	48V, MULTI 4*2A							
384W Class 2	 KVD-C24384-DIMJ (MULTI 4*96W)	24V, MULTI 4*4A	100-277 VAC	UL, cUL, FCC Pending Class2, RoHS	327*108*46mm	2.4kg	Wet, Dry, Damp	
	KVD-C48384-DIMJ (MULTI 4*96W)	48V, MULTI 4*2A						

KVD Series



- Din Rail LED Driver

UL LISTED FC Class 2 Class P TYPE HL RoHS

0/1-10V (4 in 1) - Constant Voltage

PF > 0.95 Dimming: 0-100%

for 120V&277V dimmer







Power & Picture	Model	Output	Input	Certificate	Size	N.W.	Location
60W 	KVD-12060-DIMR	12V, 5A	100-277 VAC	UL, cUL, FCC Pending Class2, RoHS	40*90*100mm	0.3kg	Dry, Damp
	KVD-24060-DIMR	24V, 2.5A		UL, cUL, FCC Pending Class2, RoHS	40*90*100mm	0.3kg	Dry, Damp
96W 	KVD-24096-DIMR	24V, 4A	100-277 VAC	UL, cUL, FCC Pending Class2, RoHS	55*90*100mm	0.4kg	Dry, Damp
100W 	KVD-12100-DIMR	12V, 8.3A	100-277 VAC	UL, cUL, FCC Pending Class2, RoHS	55*90*100mm	0.4kg	Dry, Damp
	KVD-24100-DIMR	24V, 4.17A		UL, cUL, FCC Pending Class2, RoHS	55*90*100mm	0.4kg	Dry, Damp

0-10V/1-10V/Potentiometer/10V PWM (4 in 1) Dimmable Driver Series

CE SAA RoHS

Constant Voltage



Dimming: 0-100% No min. load limit

Power & Picture	Model	Output	Input	Certificate	Size	N.W.	IP Rating	
10W 	KV-12010-P-DIM	12V, 0.83A	100-265VAC	CE, RoHS	140*45*27mm	0.15kg	IP 20 with terminals	
	KV-24010-P-DIM	24V, 0.42A						
	KV-36010-P-DIM	36V, 0.28A						
	KV-48010-P-DIM	48V, 0.21A						
20W 	KV-12020-P-DIM	12V, 1.67A	100-265VAC	CE, RoHS	140*45*27mm	0.15kg	IP 20 with terminals	
	KV-24020-P-DIM	24V, 0.83A						
	KV-36020-P-DIM	36V, 0.56A						
	KV-48020-P-DIM	48V, 0.42A						
30W 	KV-12030-P-DIM	12V, 2.5A	100-265VAC	CE, SAA, RoHS	180*60*35mm	0.45kg	IP 20 with terminals	
	KV-24030-P-DIM	24V, 1.25A						
	KV-36030-P-DIM	36V, 0.83A						
	30W 	KV-48030-P-DIM	48V, 0.63A	100-265VAC	CE, RoHS	262*28*20mm	0.35kg	IP 67
		KV-12030-A-DIM	12V, 2.5A					
		KV-24030-A-DIM	24V, 1.25A					
36W 	KV-36030-A-DIM	36V, 0.83A	100-265VAC	CE, SAA, RoHS	180*60*35mm	0.45kg	IP 20 with terminals	
	KV-48030-A-DIM	48V, 0.63A						
	KV-12036-P-DIM	12V, 3A						
	KV-24036-P-DIM	24V, 1.5A						
	36W 	KV-36036-P-DIM	36V, 1A	100-265VAC	CE, RoHS	262*28*20mm	0.35kg	IP 67
		KV-48036-P-DIM	48V, 0.75A					
		KV-12036-A-DIM	12V, 3A					
		KV-24036-A-DIM	24V, 1.5A					
36W	KV-36036-A-DIM	36V, 1A	100-265VAC	CE, RoHS	262*28*20mm	0.35kg	IP 67	
	KV-48036-A-DIM	48V, 0.75A						

0-10V/1-10V/Potentiometer/10V PWM (4 in 1) Dimmable Driver Series     

Constant Voltage

Dimming: 0-100% No min. load limit





Power & Picture	Model	Output	Input	Certificate	Size	N.W.	IP Rating	
45W 	KV-12045-P-DIM	12V, 3.75A	100-265VAC	CE, SAA, RoHS	180*60*35mm	0.45kg	IP 20 with terminals	
	KV-24045-P-DIM	24V, 1.87A						
	KV-36045-P-DIM	36V, 1.25A		CE, RoHS				
	KV-48045-P-DIM	48V, 0.94A						
60W 	KV-12060-A-DIM	12V, 5A	100-265VAC	CE, RoHS	200*70*43mm	0.95kg	IP 66	
	KV-24060-A-DIM	24V, 2.5A						
	KV-36060-A-DIM	36V, 1.67A						
	KV-48060-A-DIM	48V, 1.25A						
80W 	KV-12080-A-DIM	12V, 6.67A	100-265VAC	TUV-CE, CB, RoHS	200*70*43mm	0.95kg	IP 66	
	KV-24080-A-DIM	24V, 3.34A						
	KV-36080-A-DIM	36V, 2.23A						
	KV-48080-A-DIM	48V, 1.67A						
100W 	KV-12100-A-DIM	12V, 8.34A	100-277VAC	TUV-CE, CB, RoHS	230*70*43mm	1.1kg	IP 66	
	KV-24100-A-DIM	24V, 4.17A						
	KV-36100-A-DIM	36V, 2.78A						
	KV-48100-A-DIM	48V, 2.09A						
120W 	KV-12120-A-DIM	12V, 10A	100-277VAC	TUV-CE, CB, RoHS	256*78*47mm	1.1kg	IP 66	
	KV-24120-A-DIM	24V, 5A			230*70*43mm			
	KV-36120-A-DIM	36V, 3.34A						
	KV-48120-A-DIM	48V, 2.5A						
150W 	KV-12150-A-DIM	12V, 12.5A	100-277VAC	TUV-CE, CB, RoHS	256*78*47mm	1.5kg	IP 66	
	KV-24150-A-DIM	24V, 6.25A						
	KV-36150-A-DIM	36V, 4.17A						
	KV-48150-A-DIM	48V, 3.13A						
200W 	KV-12200-A-DIM	12V, 16.67A	100-277VAC	TUV-CE, CB, RoHS	256*78*47mm	1.5kg	IP 66	
	KV-24200-A-DIM	24V, 8.34A						
	KV-36200-A-DIM	36V, 5.56A						
	KV-48200-A-DIM	48V, 4.17A						
300W 	KV-12300-A-DIM	12V, 25A	100-277VAC	TUV-CE, CB, RoHS	276*78*47mm	1.7kg	IP 66	
	KV-24300-A-DIM	24V, 12.5A						
320W 	KV-12320-A-DIM	12V, 26.67A	170-265VAC	TUV-CE, CB, RoHS	276*78*47mm	1.7kg	IP 66	
	KV-24320-A-DIM	24V, 13.3A		CE, RoHS				
360W 	KV-12360-A-DIM	12V, 30A			CE, RoHS	276*78*47mm	1.7kg	IP 66
	KV-24360-A-DIM	24V, 15A			TUV-CE, CB, RoHS			

0-10V/1-10V/Potentiometer/10V PWM (4 in 1) Dimmable Driver Series



Constant Current

Dimming: 0-100%







Power & Picture	Model	Output	Input	Certificate	Size	N.W.	IP Rating
10W 	KI-30350-P-DIM	20-30V 350mA	100-265VAC	CE, RoHS	140*45*27mm	0.15kg	IP 20 with terminals
	KI-20500-P-DIM	14-20V 500mA					
	KI-15700-P-DIM	10-15V 700mA					
	KI-12900-P-DIM	7-12V 900mA					
20W 	KI-50350-P-DIM	30-50V 350mA	100-265VAC	CE, RoHS	140*45*27mm	0.2kg	IP 20 with terminals
	KI-35500-P-DIM	20-35V 500mA					
	KI-25700-P-DIM	15-25V 700mA					
	KI-20900-P-DIM	12-20V 900mA					
30W 	KI-50350-A-DIM	30-50V 350mA	100-265VAC	CE, RoHS	262*29*20mm	0.35kg	IP 67
	KI-35500-A-DIM	21-35V 500mA					
	KI-25700-A-DIM	15-25V 700mA					
	KI-20900-A-DIM	12-20V 900mA					
36W 	KI-80350-P-DIM	50-80V 350mA	100-265VAC	CE, SAA, RoHS	180*60*35mm	0.45kg	IP 20 with terminals
	KI-60500-P-DIM	36-60V 500mA		CE, RoHS			
	KI-45700-P-DIM	25-45V 700mA					
	KI-36900-P-DIM	20-36V 900mA					
36W 	KI-301050-P-DIM	18-30V 1050mA	100-265VAC	CE, RoHS	262*29*20mm	0.35kg	IP 67
	KI-80350-A-DIM	48-80V 350mA					
	KI-60500-A-DIM	36-60V 500mA					
	KI-45700-A-DIM	27-45V 700mA					
36W 	KI-36900-A-DIM	22-36V 900mA	100-265VAC	CE, RoHS	180*60*35mm	0.45kg	IP 20 with terminals
	KI-301050-A-DIM	18-30V 1050mA					
	KI-75500-P-DIM	45-75V 500mA					
	KI-55700-P-DIM	30-55V 700mA					
36W 	KI-42900-P-DIM	25-42V 900mA	100-265VAC	CE, RoHS	262*29*20mm	0.35kg	IP 67
	KI-361050-P-DIM	20-36V 1050mA					
	KI-251400-P-DIM	15-25V 1400mA					
	KI-75500-A-DIM	45-75V 500mA					
36W 	KI-55700-A-DIM	33-55V 700mA	100-265VAC	CE, RoHS	262*29*20mm	0.35kg	IP 67
	KI-42900-A-DIM	25-42V 900mA					
	KI-361050-A-DIM	20-36V 1050mA					
	KI-251400-A-DIM	15-25V 1400mA					
45W 	KI-120350-P-DIM	70-120V 350mA	100-265VAC	CE, RoHS	180*60*35mm	0.45kg	IP 20 with terminals
	KI-90500-P-DIM	55-90V 500mA					
	KI-65700-P-DIM	40-65V 700mA					
	KI-50900-P-DIM	30-50V 900mA					
45W 	KI-321400-P-DIM	20-32V 1400mA		CE, SAA, RoHS			
	KI-451050-P-DIM	28-45V 1050mA					

0-10V/1-10V/Potentiometer/10V PWM (4 in 1) Dimmable Driver Series



Constant Current

Dimming: 0-100%



Power & Picture	Model	Output	Input	Certificate	Size	N.W	IP
60W 	KI-120500-A-DIM	70-120V 500mA	100-265VAC	CE, RoHS	200*70*43mm	0.95kg	IP66
	KI-85700-A-DIM	50-85V 700mA					
	KI-70900-A-DIM	40-70V 900mA					
	KI-601050-A-DIM	36-60V 1050mA					
	KI-421400-A-DIM	25-42V 1400mA					
	KI-361750-A-DIM	20-36V 1750mA					
KI-302100-A-DIM	18-30V 2100mA						
80W 	KI-85900-A-DIM	50-85V 900mA	100-265VAC	CE, RoHS	200*70*43mm	0.95kg	IP66
	KI-751050-A-DIM	45-75V 1050mA					
	KI-551400-A-DIM	35-55V 1400mA					
	KI-451750-A-DIM	28-45V 1750mA					
	KI-362100-A-DIM	20-36V 2100mA					
	KI-302500-A-DIM	18-30V 2500mA					
100W 	KI-150700-A-DIM	80-150V 700mA	100-277VAC	CE, RoHS	230*70*43mm	1.1kg	IP66
	KI-110900-A-DIM	60-110V 900mA					
	KI-901050-A-DIM	55-90V 1050mA					
	KI-701400-A-DIM	45-70V 1400mA					
	KI-601750-A-DIM	36-60V 1750mA					
	KI-482100-A-DIM	30-48V 2100mA					
	KI-402500-A-DIM	25-40V 2500mA					
KI-353000-A-DIM	21-35V 3000mA						
120W 	KI-130900-A-DIM	70-130V 900mA	100-277VAC	CE, RoHS	230*70*43mm	1.1kg	IP66
	KI-1151050-A-DIM	60-115V 1050mA					
	KI-851400-A-DIM	50-85V 1400mA					
	KI-701750-A-DIM	40-70V 1750mA					
	KI-552100-A-DIM	33-55V 2100mA					
	KI-502450-A-DIM	30-50V 2450mA					
	KI-422800-A-DIM	25-42V 2800mA					
	KI-363500-A-DIM	20-36V 3500mA					
150W 	KI-702100-A-DIM	45-70V 2100mA	100-277VAC	CE, RoHS	256*78*47mm	1.5kg	IP66
	KI-602500-A-DIM	40-60V 2500mA					
	KI-502800-A-DIM	30-50V 2800mA					
	KI-503100-A-DIM	30-50V 3100mA					
	KI-423500-A-DIM	25-42V 3500mA					
	KI-364200-A-DIM	24-36V 4200mA					
200W 	KI-802500-A-DIM	50-80V 2500mA	100-277VAC	CE, RoHS	256*78*47mm	1.5kg	IP66
	KI-702800-A-DIM	45-70V 2800mA					
	KI-653100-A-DIM	40-65V 3100mA					
	KI-366500-A-DIM	24-36V 6500mA					

0-10V/1-10V/Potentiometer/10V PWM (4 in 1) Dimmable Driver Series



Constant Current - DIP Adjustment for multiple output current

Dimming: 0-100%

Power & Picture	Model	Output	Input	Certificate	Size	N.W.	IP Rating
20W 	KI-020-P-DIM DIP Adjustment (Multi-current)	3-40V 250mA ○○○	100-265 VAC	CE, RoHS	140*45*27mm	0.15kg	IP 20 with terminals
		3-40V 350mA ●○○					
		3-40V 400mA ○●○					
		3-40V 450mA ○○●					
		3-40V 500mA ●●○					
		3-35V 550mA ●●●					
		3-30V 600mA ○●●					
3-25V 700mA ●●●							
50W 	KI-050-P-DIM DIP Adjustment (Multi-current)	10-50V 700mA ○○○○	100-265 VAC	CE, RoHS	178*61*24mm	0.35kg	IP 20 with terminals
		10-50V 900mA ●○○○					
		10-48V 1050mA ●●○○					
		10-42V 1200mA ●●●○					
		10-36V 1400mA ●●●●○					
		10-34V 1500mA ●●●●●					

PART 4

DALI dimmable LED Driver

(For LED strip, light bar, LED module, panel, down light and other LED light)

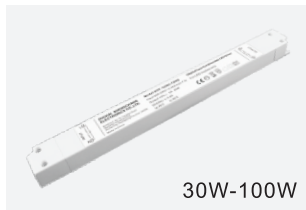

Wiring diagram

Diagram 1

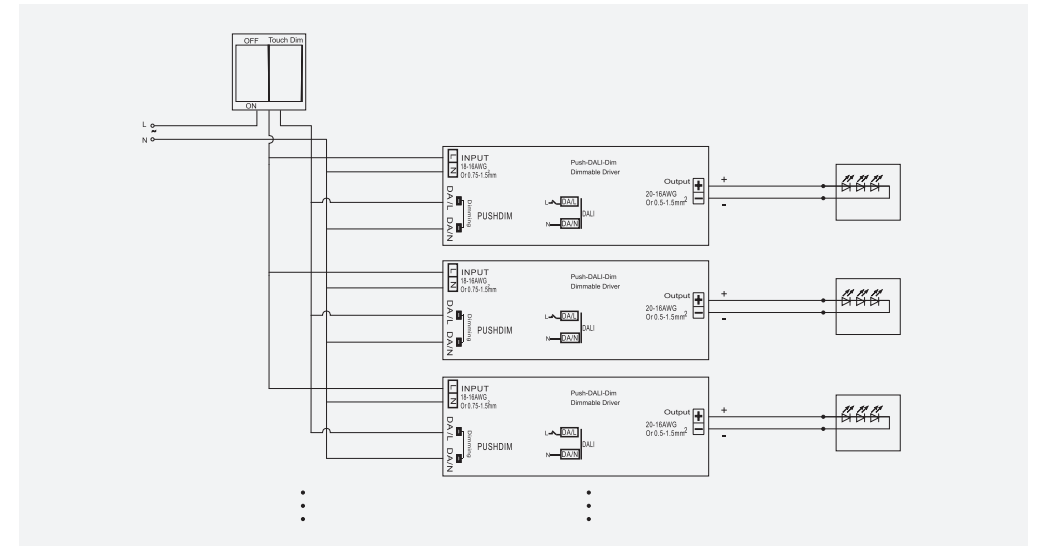
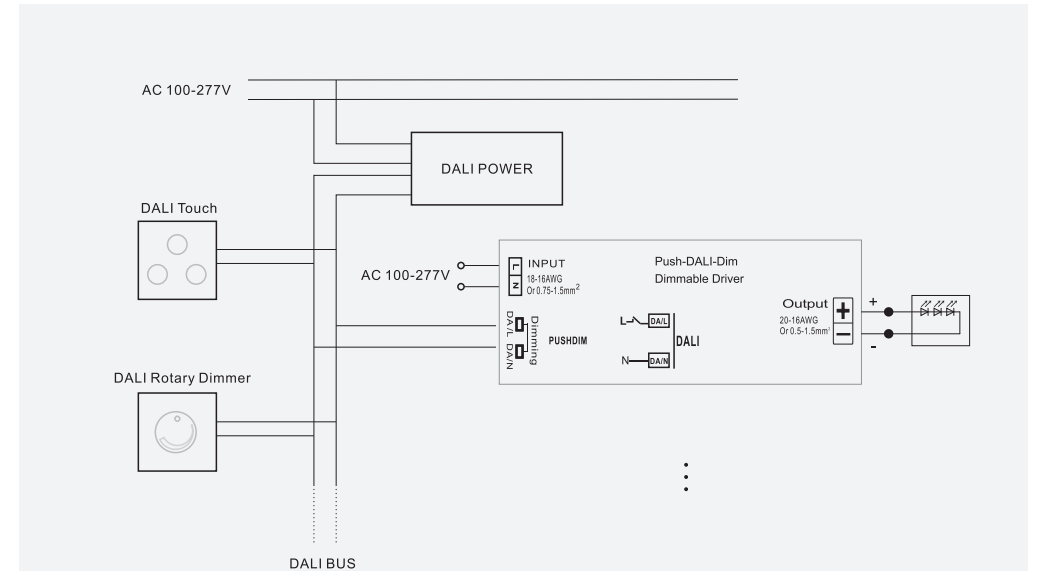

Diagram 2



DALI Dimming LED Driver Series



Overview

CERULEAN'S 100-265V universal DP of constant voltage TUV-CE CB RoHS DALI dimmable driver, its 0-100% dimming performance, universal compatibility and flicker-free attract a lot of customers. Also with high PF & efficiency are designed for the energy saving, with two dimming functions can save mass stocking. Adopted in many LED lights, say LED tape/strip, modules, LED bar light, cabinet light, kitchen light and other LED fixtures.

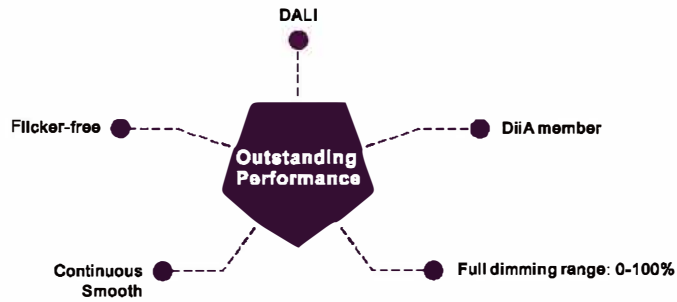

Different versions

KV-xxxxx-DP



Constant voltage
25W-75W Items:
 Low-profile durable plastic shell
80W-360W Items:
 Compact aluminum shell for outdoor use waterproof rating IP66

KV-xxxxx-DPS/DPL



Constant voltage
DPS Items:
 Linear plastic shell (IP 20)
DPL Items:
 Linear aluminum shell for outdoor use waterproof rating (IP 66)

KI-xxxxx-DP



Constant current LED driver with DIP adjustment (8 levels current selectable), makes it easy for multi-current and simplify the inventory.
 Linear aluminum shell

Perfect for LED fixtures

Perfect to use for LED tape/strip, modules, LED bar light, cabinet light, kitchen light, down light, panel light and other LED fixtures.



DALI Dimming LED Driver Series



Constant Voltage

Dimming: 0-100%

Power & Picture	Model	Output	Input	Certificate	Size	N.W.	IP Rating	
25W	KV-12025-DP	12V, 2.08A	100-265VAC	CE, RoHS	154*54*20mm	0.21kg	IP 20 with terminals	
	KV-24025-DP	24V, 1.04A						
30W	KV-12030-DPS	12V, 2.5A	100-277VAC	TUV Pending, RoHS	260*30*18.5mm	0.2kg	IP 20 with terminals	
	KV-24030-DPS	24V, 1.25A						
		KV-12030-DPL		12V, 2.5A	TUV Pending, RoHS	260*32*18.5mm	0.35kg	IP 66
		KV-24030-DPL		24V, 1.25A				
36W	KV-12036-DPS	12V, 3A	100-277VAC	TUV Pending, RoHS	260*30*18.5mm	0.2kg	IP 20 with terminals	
	KV-24036-DPS	24V, 1.5A						
		KV-12036-DPL		12V, 3A	TUV Pending, RoHS	260*32*18.5mm	0.35kg	IP 66
		KV-24036-DPL		24V, 1.5A				
50W	KV-12050-DP	12V, 4.17A	100-265VAC	CE, RoHS	178*61*24mm	0.35kg	IP 20 with terminals	
	KV-24050-DP	24V, 2.08A						
60W	KV-12060-DPS	12V, 5A	100-277VAC	TUV Pending, RoHS	300*30*18.5mm	0.3kg	IP 20 with terminals	
	KV-24060-DPS	24V, 2.5A						
		KV-12060-DPL		12V, 5A	TUV Pending, RoHS	300*32*20mm	0.45kg	IP 66
		KV-24060-DPL		24V, 2.5A				
75W	KV-12075-DP	12V, 6.25A	100-277VAC	CE, RoHS	180*60*35mm	0.45kg	IP 20 with terminals	
	KV-24075-DP	24V, 3.1A						
90W	KV-12090-DP	12V, 7.5A	100-277VAC	CE, RoHS	180*60*35mm	0.45kg	IP 20 with terminals	
	KV-24090-DP	24V, 3.1A						
80W	KV-12080-DP	12V, 6.67A	100-277VAC	TUV-CE, CB, RoHS	210*70*43mm	1.1kg	IP 66	
	KV-24080-DP	24V, 3.34A						

DALI Dimming LED Driver Series

Constant Voltage

Dimming: 0-100%



Power & Picture	Model	Output	Input	Certificate	Size	N.W.	IP Rating
	KV-12100-DPS	12V, 8.33A	100-277VAC	TUV Pending, RoHS	330*30*22mm	0.4kg	IP 20 with terminals
	KV-24100-DPS	24V, 4.17A					
	KV-12100-DPL	12V, 8.33A		TUV Pending, RoHS	330*32*23mm	0.55kg	IP 66
	KV-24100-DPL	24V, 4.17A					
	KV-12100-DP	12V, 8.34A		TUV-CE, CB, RoHS	210*70*43mm	1.1kg	IP 66
	KV-24100-DP	24V, 4.17A					
	KV-12120-DP	12V, 10A	100-277VAC	TUV-CE, CB, RoHS	210*70*43mm	1.1kg	IP 66
	KV-24120-DP	24V, 5A					
	KV-12150-DP	12V, 12.5A	100-277VAC	TUV-CE, CB, RoHS	245*70*43mm	1.4kg	IP 66
	KV-24150-DP	24V, 6.25A					
	KV-12200-DP	12V, 16.67A	100-277VAC	TUV-CE, CB, RoHS	245*70*43mm	1.4kg	IP 66
	KV-24200-DP	24V, 8.34A					
	KV-12300-DP	12V, 25A	100-277VAC	TUV-CE, CB, RoHS	276*78*47mm	1.7kg	IP 66
	KV-24300-DP	24V, 12.5A					
	KV-12320-DP	12V, 26.67A	100-277VAC	TUV-CE, CB, RoHS	276*78*47mm	1.7kg	IP 66
	KV-24320-DP	24V, 13.34A					
	KV-12360-DP	12V, 30A	100-277VAC	CE, RoHS	276*78*47mm	1.7kg	IP 66
	KV-24360-DP	24V, 15A					

DALI Dimming LED Driver Series

Constant Current

Dimming: 0-100%



Power & Picture	Model	Output	Input	Certificate	Size	N.W.	IP Rating
	KI-020-DA DIP Adjustment (Multi-current)	3-50V 250mA ○○○	100-265 VAC	CE, RoHS	140*45*27mm	0.15kg	IP 20
		3-50V 350mA ●○○					
		3-50V 400mA ○●○					
		3-45V 450mA ○○●					
		3-40V 500mA ●●○					
		3-35V 550mA ●●●					
		3-30V 600mA ○●●					
3-25V 700mA ●●●							
	KI-050-DA DIP Adjustment (Multi-current)	10-50V 700mA ○○○ ○○	100-265 VAC	CE, RoHS	178*61*24mm	0.35kg	IP 20
		10-50V 900mA ●○○ ○○					
		10-48V 1050mA ●●○ ○○					
		10-42V 1200mA ●●● ○○					
		10-36V 1400mA ●●● ●○					
		10-34V 1500mA ●●● ●●					
	KI-80350-DA KI-60500-DA KI-45700-DA KI-36900-DA KI-301050-DA	56-80V 350mA	100-277VAC	CE, RoHS	180*60*35mm	0.5kg	IP20 with terminals
		42-60V 500mA					
		32-45V 700mA					
		25-36V 900mA					
	KI-75500-DA KI-55700-DA KI-42900-DA KI-361050-DA KI-251400-DA	52-75V 500mA	100-277VAC	CE, RoHS	180*60*35mm	0.5kg	IP20 with terminals
		38-55V 700mA					
		29-42V 900mA					
		25-36V 1050mA					
		17-25V 1400mA					
	KI-90500-DA KI-65700-DA KI-50900-DA KI-451050-DA KI-351400-DA	63-90V 500mA	100-277VAC	CE, RoHS	180*60*35mm	0.5kg	IP20 with terminals
		45-65V 700mA					
		35-50V 900mA					
		31-45V 1050mA					
		25-35V 1400mA					
	KI-85700-DA KI-65900-DA KI-601050-DA KI-451400-DA KI-361750-DA KI-302100-DA	59-85V 700mA	100-277VAC	CE, RoHS	210*70*43mm	1.05kg	IP66
		45-65V 900mA					
		42-60V 1050mA					
		31-45V 1400mA					
		25-36V 1750mA					
		21-30V 2100mA					

DALI Dimming LED Driver Series



Constant Current

Dimming: 0-100%

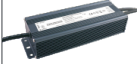
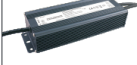
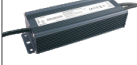
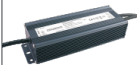
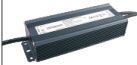

Power & Picture	Model	Output	Input	Certificate	Size	N.W.	IP Rating
80W 	KI-85900-DA	59-85V 900mA	100-277VAC	CE, RoHS	210*70*43mm	1.05kg	IP66
	KI-751050-DA	52-75V 1050mA					
	KI-551400-DA	38-55V 1400mA					
	KI-451750-DA	32-45V 1750mA					
	KI-362100-DA	25-36V 2100mA					
	KI-302500-DA	21-30V 2500mA					
100W 	KI-150700-DA	105-150V 700mA	100-277VAC	CE, RoHS	230*70*43mm	1.1kg	IP66
	KI-110900-DA	77-110V 900mA					
	KI-901050-DA	63-90V 1050mA					
	KI-701400-DA	49-70V 1400mA					
	KI-601750-DA	42-60V 1750mA					
	KI-482100-DA	33-48V 2100mA					
	KI-402500-DA	28-40V 2500mA					
	KI-363000-DA	25-36V 3000mA					
120W 	KI-130900-DA	91-130V 900mA	100-277VAC	CE, RoHS	230*70*43mm	1.1kg	IP66
	KI-1151050-DA	80-115V 1050mA					
	KI-851400-DA	59-85V 1400mA					
	KI-701750-DA	49-70V 1750mA					
	KI-552100-DA	38-55V 2100mA					
	KI-502450-DA	35-50V 2450mA					
	KI-422800-DA	29-42V 2800mA					
KI-363500-DA	25-36V 3500mA						
150W 	KI-702100-DA	49-70V 2100mA	100-277VAC	CE, RoHS	256*78*47mm	1.5kg	IP66
	KI-602500-DA	42-60V 2500mA					
	KI-502800-DA	35-50V 2800mA					
	KI-503100-DA	35-50V 3100mA					
	KI-423500-DA	29-42V 3500mA					
	KI-364200-DA	25-36V 4200mA					
200W 	KI-802500-DA	56-80V 2500mA	100-277VAC	CE, RoHS	256*78*47mm	1.5kg	IP66
	KI-702800-DA	49-70V 2800mA					
	KI-653100-DA	45-65V 3100mA					
	KI-366500-DA	25-36V 6500mA					

DALI Dimming LED Driver Series



Constant Current - DIP Adjustment for multiple output current

Dimming: 0-100%

Power & Picture	Model	Output	Input	Certificate	Size	N.W.	IP Rating
20W 	KI-020-DP DIP Adjustment (Multi-current)	3-50V 250mA ○○○	100-265 VAC	CE, SAA, RoHS	245*30*20.5mm	0.2kg	IP 20
		3-50V 350mA ●○○					
		3-50V 400mA ○●○					
		3-45V 450mA ○○●					
		3-40V 500mA ●●○					
		3-35V 550mA ●○●					
		3-30V 600mA ○●●					
		3-25V 700mA ●●●					
40W 	KI-040-DP DIP Adjustment (Multi-current)	10-50V 600mA ○○○	100-265 VAC	CE, SAA, RoHS	285*30*20.5mm	0.3kg	IP 20
		10-50V 700mA ●○○					
		10-50V 750mA ○○●					
		10-50V 800mA ○●○					
		10-48V 850mA ●○●					
		10-45V 900mA ●●○					
		10-42V 950mA ○●●					
		10-35V 1050mA ●●●					

PART 5

Non-Dimming LED Driver Series (PFC EMC high power factor)

(For LED strip, light bar, LED module, panel, down light and other LED light)



Non-Dimming LED Driver Series (PFC EMC, high power factor)

Overview

CERULEAN'S 100-277VAC universal KV-XXX-ASW/ASWJ of Constant Voltage cUL Listed LED driver, with high power factor up to 0.99, high efficiency, THD is lower than 10% and no minimum load request. Suitable for LED bar light, cabinet light, kitchen light and other LED fixtures.

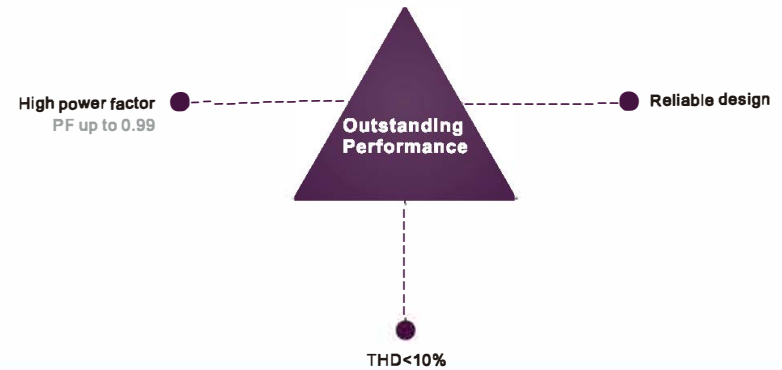

Different versions

KV-xxxxx-ASW KV-Cxxxxx-ASW



30W-60W Items:
Plastic case for indoor use with terminal blocks enable easy and safe installation

80W-300W Items:
Compact aluminum enclosure for outdoor waterproof use with UL approved

KV-xxxxx-ASS/ASL



Slim & low-profile size Items:
Width < 32mm, Height < 23mm

ASS items:
Linear plastic case (IP 20)

ASL Items:
Linear aluminum enclosure for outdoor waterproof use (IP 66)

KV-xxxxx-ASWJ/ KV-Cxxxxx-ASWJ



30W-300W items:
Low-profile aluminum enclosure with 6 knock-outs and input and output electrical cables enables easy installation

Perfect for LED fixtures







Perfect to use for LED tape/strip, modules, LED bar light, cabinet light, kitchen light and other LED fixtures.

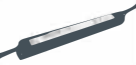

PFC EMC High power factor constant voltage driver

PF up to 0.99

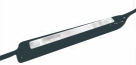









  **Class 2 Class P TYPE HL**  

Power & Picture	Model	Output	Input	Certificate	Size	N.W.	Location	
30W Class 2		KV-12030-ASS	12V, 2.5A	100-277 VAC	UL, cUL, FCC Pending CE, RoHS	260*30*18.5mm	0.2kg	Dry, Damp
		KV-24030-ASS	24V, 1.25A					
		KV-36030-ASS	36V, 0.83A					
		KV-48030-ASS	48V, 0.63A					
		KV-12030-ASL	12V, 2.5A		UL, cUL, FCC Pending CE, RoHS	260*32*20mm	0.35kg	Wet, Dry, Damp
		KV-24030-ASL	24V, 1.25A					
		KV-36030-ASL	36V, 0.83A					
		KV-48030-ASL	48V, 0.63A		UL, cUL, FCC, CE, RoHS	155*54*20mm	0.21kg	Dry, Damp
		KV-12030-ASW	12V, 2.5A					
		KV-24030-ASW	24V, 1.25A					
		KV-38030-ASW	36V, 0.83A					
		KV-48030-ASW	48V, 0.63A		UL, cUL, FCC Pending CE, RoHS	165*92*41mm	0.95kg	Dry, Damp
	KV-12030-ASWJ	12V, 2.5A						
	KV-24030-ASWJ	24V, 1.25A						
	KV-36030-ASWJ	36V, 0.83A						
	KV-48030-ASWJ	48V, 0.63A						
	KV-36030-ASWJV5	36V, 0.83A						
	KV-48030-ASWJV5	48V, 0.63A	UL, cUL, FCC Pending CE, RoHS	165*112*26mm	1.05kg	Dry, Damp		
	KV-12030-ASWJV2	12V, 2.5A						
	KV-24030-ASWJV2	24V, 1.25A						
	KV-36030-ASWJV2	36V, 0.83A						
	KV-48030-ASWJV2	48V, 0.63A	UL, cUL, FCC, CE, RoHS	350*77*28mm	0.65kg	Dry, Damp		
	KV-12036-ASS	12V, 3A						
	KV-24036-ASS	24V, 1.5A						
	KV-36036-ASS	36V, 1A						
36W Class 2		KV-48036-ASS	48V, 0.75A	100-277 VAC	280*30*18.5mm	0.2kg	Dry, Damp	
		KV-12036-ASL	12V, 3A					
		KV-24036-ASL	24V, 1.5A					
		KV-36036-ASL	36V, 1A					
	KV-48036-ASL	48V, 0.75A	UL, cUL, FCC Pending CE, RoHS	260*32*20mm	0.35kg	Wet, Dry, Damp		
	KV-12060-ASS	12V, 5A						
	KV-24060-ASS	24V, 2.5A						
60W Class 2		KV-36060-ASS	36V, 1.67A	100-277 VAC	300*30*18.5mm	0.3kg	Dry, Damp	
		KV-48060-ASS	48V, 1.25A					
		KV-12060-ASL	12V, 5A					
		KV-24060-ASL	24V, 2.5A					
		KV-36060-ASL	36V, 1.67A					
		KV-48060-ASL	48V, 1.25A					

PFC EMC High power factor constant voltage driver

PF up to 0.99

  **Class 2 Class P TYPE HL**  

Power & Picture	Model	Output	Input	Certificate	Size	N.W.	Location	
60W		KV-12060-ASW	12V, 5A	100-277 VAC	UL, cUL, FCC, CE, RoHS	178*61*24mm	0.35kg	Dry, Damp
		KV-24060-ASW	24V, 2.5A					
		KV-36060-ASW	36V, 1.67A					
		KV-48060-ASW	48V, 1.25A					
		KV-12060-ASWJ	12V, 5A		UL, cUL, FCC, CE, RoHS	188*92*41mm	1.1kg	Dry, Damp
		KV-24060-ASWJ	24V, 2.5A					
		KV-36060-ASWJ	36V, 1.67A					
		KV-48080-ASWJ	48V, 1.25A		UL, cUL, FCC Pending CE, RoHS	188*112*26mm	1.2kg	Dry, Damp
		KV-38080-ASWJV5	38V, 1.67A					
		KV-48080-ASWJV5	48V, 1.25A					
		KV-12060-ASWJV2	12V, 5A					
		KV-24080-ASWJV2	24V, 2.5A		UL, cUL, FCC, CE, RoHS	350*77*26mm	0.75kg	Dry, Damp
	KV-36060-ASWJV2	36V, 1.67A						
	KV-48080-ASWJV2	48V, 1.25A	UL, cUL, FCC Pending CE, RoHS	330*30*22mm	0.4kg	Dry, Damp		
	KV-24096-ASS	24V, 4A						
	KV-36096-ASS	36V, 2.67A						
	KV-48096-ASS	48V, 2A						
80W 96W Class 2		KV-24096-ASL	24V, 4A	100-277 VAC	UL, cUL, FCC Pending CE, RoHS	330*32*23mm	0.55kg	Wet, Dry, Damp
		KV-36096-ASL	36V, 2.67A					
		KV-48096-ASL	48V, 2A					
		KV-24080-ASW	24V, 3.33A		UL, cUL, FCC, CE, RoHS	230*70*43mm	1.1kg	Wet, Dry, Damp
		KV-24096-ASW	24V, 4A					
		KV-36096-ASW	36V, 2.67A					
		KV-48096-ASW	48V, 2A					
		KV-24080-ASWJ	24V, 3.33A		UL, cUL, FCC, CE, RoHS	220*93*41mm	1.3kg	Dry, Damp
		KV-24096-ASWJ	24V, 4A					
		KV-36096-ASWJ	36V, 2.67A					
		KV-48096-ASWJ	48V, 2A		UL, cUL, FCC Pending CE, RoHS	380*77*57mm	1.8kg	Wet, Dry, Damp
		KV-24080-ASWJV2	24V, 3.33A					
	KV-24096-ASWJV2	24V, 4A						
	KV-36096-ASWJV2	36V, 2.67A						
	KV-48096-ASWJV2	48V, 2A	UL, cUL, FCC Pending CE, RoHS	380*77*57mm	1.8kg	Dry, Damp		
	KV-24096-ASWJV2	24V, 4A						
	KV-36096-ASWJV2	36V, 2.67A						
	KV-48096-ASWJV2	48V, 2A						

PFC EMC High power factor constant voltage driver

PF up to 0.99



Power & Picture	Model	Output	Input	Certificate	Size	N.W.	Location	
	KV-12100-ASS	12V, 8.33A	100-277 VAC	UL, cUL, FCC Pending CE, RoHS	330*30*22mm	0.4kg	Dry, Damp	
	KV-24100-ASS	24V, 4.17A						
	KV-36100-ASS	36V, 2.78A						
	KV-48100-ASS	48V, 2.08A						
		KV-12100-ASL		12V, 8.33A	UL, cUL, FCC Pending CE, RoHS	330*32*23mm	0.55kg	Wet, Dry, Damp
		KV-24100-ASL		24V, 4.17A				
		KV-36100-ASL		36V, 2.78A				
		KV-48100-ASL		48V, 2.08A				
		KV-12100-ASW		12V, 8.33A	UL, cUL, FCC, CE, RoHS	230*70*43mm	1.1kg	Wet, Dry, Damp
		KV-24100-ASW		24V, 4.16A				
		KV-36100-ASW		36V, 2.78A				
		KV-48100-ASW		48V, 2.08A				
	KV-12100-ASWJ	12V, 8.33A	UL, cUL, FCC, CE, RoHS	220*93*41mm	1.3kg	Dry, Damp		
	KV-24100-ASWJ	24V, 4.16A						
	KV-36100-ASWJ	36V, 2.78A						
	KV-48100-ASWJ	48V, 2.08A						
	KV-12100-ASWJV2	12V, 8.33A	UL, cUL, FCC, CE, RoHS	380*77*57mm	1.8kg	Dry, Damp		
	KV-24100-ASWJV2	24V, 4.16A						
	KV-36100-ASWJV2	36V, 2.78A						
	KV-48100-ASWJV2	48V, 2.08A						
	KV-12120-ASW	12V, 10A	100-277 VAC	UL, cUL, FCC, CE, RoHS	230*70*43mm	1.1kg	Wet, Dry, Damp	
	KV-24120-ASW	24V, 5A						
	KV-36120-ASW	36V, 3.33A						
		KV-48120-ASW		48V, 2.5A	UL, cUL, FCC Pending CE, RoHS	220*93*41mm	1.3kg	Dry, Damp
		KV-12120-ASWJ		12V, 10A				
		KV-24120-ASWJ		24V, 5A				
		KV-36120-ASWJ		36V, 3.33A	UL, cUL, FCC Pending CE, RoHS	380*77*57mm	1.8kg	Wet, Dry, Damp
		KV-48120-ASWJ		48V, 2.5A				
		KV-12120-ASWJV2		12V, 10A				
		KV-24120-ASWJV2		24V, 5A				
		KV-36120-ASWJV2		36V, 3.33A	UL, cUL, FCC Pending CE, RoHS	380*77*57mm	1.8kg	Dry, Damp
		KV-48120-ASWJV2		48V, 2.5A				

PFC EMC High power factor constant voltage driver

PF up to 0.99



Power & Picture	Model	Output	Input	Certificate	Size	N.W.	Location	
	KV-12150-ASW	12V, 12.5A	110-277 VAC	UL, cUL, FCC, CE, RoHS	256*78*47mm	1.5kg	Wet, Dry, Damp	
	KV-24150-ASW	24V, 8.25A						
	KV-36150-ASW	36V, 4.17A						
	KV-48150-ASW	48V, 3.13A						
		KV-12150-ASWJ		12V, 12.5A	UL, cUL, FCC, CE, RoHS	260*103*46mm	1.8kg	Dry, Damp
		KV-24150-ASWJ		24V, 6.25A				
		KV-36150-ASWJ		36V, 4.17A				
		KV-48150-ASWJ		48V, 3.13A				
		KV-12150-ASWJV2		12V, 12.5A	UL, cUL, FCC, CE, RoHS	408*87*60mm	2.3kg	Dry, Damp
		KV-24150-ASWJV2		24V, 8.25A				
		KV-36150-ASWJV2		36V, 4.17A				
		KV-48150-ASWJV2		48V, 3.13A				
	KV-C12180-ASW (MULTI 3*60W)	12V, MULTI 3*5A	110-277 VAC	UL, cUL, FCC Pending CE, RoHS	256*78*47mm	1.5kg	Wet, Dry, Damp	
	KV-C24192-ASW (MULTI 2*96W)	24V, MULTI 2*4A						
		KV-C12180-ASWJ (MULTI 3*60W)		12V, MULTI 3*5A	UL, cUL, FCC Pending CE, RoHS	260*103*46mm	1.8kg	Wet, Dry, Damp
		KV-C24192-ASWJ (MULTI 2*96W)		24V, MULTI 2*4A				
		KV-C12180-ASWJV2 (MULTI 3*60W)		12V, MULTI 3*5A	UL, cUL, FCC Pending CE, RoHS	455*87*60mm	2.3kg	Dry, Damp
		KV-C24192-ASWJV2 (MULTI 2*96W)		24V, MULTI 2*4A				
	KV-12200-ASW	12V, 16.6A	110-277 VAC	UL, cUL, FCC, CE, RoHS	256*78*47mm	1.5kg	Wet, Dry, Damp	
	KV-24200-ASW	24V, 8.33A						
	KV-36200-ASW	36V, 5.58A						
		KV-48200-ASW		48V, 4.17A	UL, cUL, FCC, CE, RoHS	260*103*46mm	1.8kg	Dry, Damp
		KV-12200-ASWJ		12V, 16.6A				
		KV-24200-ASWJ		24V, 8.33A				
		KV-36200-ASWJ		36V, 5.56A	UL, cUL, FCC Pending CE, RoHS	380*77*57mm	1.8kg	Wet, Dry, Damp
		KV-48200-ASWJ		48V, 4.17A				
		KV-12200-ASWJV2		12V, 16.6A				
		KV-24200-ASWJV2		24V, 8.33A				
		KV-36200-ASWJV2		36V, 5.58A	UL, cUL, FCC Pending CE, RoHS	408*87*60mm	1.8kg	Dry, Damp
		KV-48200-ASWJV2		48V, 4.17A				

PFC EMC High power factor constant voltage driver

PF up to 0.99



Power & Picture	Model	Output	Input	Certificate	Size	N.W.	Location
288W 300W Class2   	KV-C24288-ASW (MULTI 3×96W)	24V, MULTI 3×4A	110-277 VAC	UL, cUL, FCC Pending CE, RoHS	301*78*47mm	1.9kg	Wet, Dry, Damp
	KV-C12300-ASW (MULTI 5×60W)	12V, MULTI 5×5A					
	KV-C24288-ASWJ (MULTI 3×96W)	24V, MULTI 3×4A		UL, cUL, FCC Pending CE, RoHS	301*108*46mm	2.2kg	Wet, Dry, Damp
	KV-C12300-ASWJ (MULTI 5×60W)	12V, MULTI 5×5A					
	KV-C24288-ASWJV2 (MULTI 3×96W)	24V, MULTI 3×4A		UL, cUL, FCC Pending CE, RoHS	455*87*60mm	2.5kg	Dry, Damp
	KV-C12300-ASWJV2 (MULTI 5×60W)	12V, MULTI 5×5A					
300W   	KV-12300-ASW	12V, 25A	110-277 VAC	UL, cUL, FCC, CE, RoHS	276*78*47mm	1.7kg	Wet, Dry, Damp
	KV-24300-ASW	24V, 12.5A					
	KV-36300-ASW	36V, 8.33A					
	KV-48300-ASW	48V, 6.25A					
	KV-12300-ASWJ	12V, 25A		UL, cUL, FCC, CE, RoHS	278*108*46mm	2.0kg	Dry, Damp
	KV-24300-ASWJ	24V, 12.5A					
	KV-36300-ASWJ	36V, 8.33A					
	KV-48300-ASWJ	48V, 6.25A					
	KV-12300-ASWJV2	12V, 25A		UL, cUL, FCC, CE, RoHS	455*87*60mm	2.0kg	Dry, Damp
	KV-24300-ASWJV2	24V, 12.5A					
	KV-36300-ASWJV2	36V, 8.33A					
	KV-48300-ASWJV2	48V, 6.25A					
				UL, cUL, FCC Pending CE, RoHS			